

Section 8 Grounding Products

	Description.....	Page #
8.1	QuikTap™	168-171
8.2	Ground Rods and Accessories	172-173
8.3	Chemical Ground Rod Kits	174-175
8.4	Contact-GM	176-177
8.5	Ground Access Wells	178-180
8.6	Ground Bars: UL Listed	181-187
8.7	Standoff Insulators & Mounting Brackets.....	188
8.8	Perimeter Bus Bars	189-191
8.9	Copper Lugs	192-194
8.10	Prefabricated Lug Bonds.....	195-196
8.11	Rebar Bonds	196
8.12	Prefabricated Copper Ground Mesh: UL Listed	197-199
8.13	CC-14 Cable to Cable Connection	199
8.14	Copper Ground Plates	200
8.15	Pole Plates	201
8.16	T-Wrap	202
8.18	Pipe Clamps, Universal Pipe Clamps & Fence Clamp Assemblies ..	203-205
8.19	Flexible Gate Jumpers & Fence Gate Assemblies	206-209
8.20	Fence Fabric Ground Clamps	210
8.21	Signal Reference Grid (SRG)	211
8.22	Low Impedance Risers (L.I.R.)	212
8.23	Cable to Floor Pedestal Connections	212
8.24	Cable to (SRG) Connections	213
8.25	Cable to Steel Connections.....	213
8.26	Cable to Copper Lug Connections	213
8.27	Computer Room Ground Clamps	214

QUIKTAP™



Introducing thermOweld's QuikTap™ Ground Rod Connection

The QuikTap™ is a multi functional grounding solution that allows you to connect to a ground rod using a irreversible connection.

Whether you want to connect multiple grounding conductors to create a grounding grid, ground/bus bars, fences, or lightning protection systems, QuikTap™ is the quick and easy way to install your grounding system in the field without the need for a burn permit or concern around volatile or hazardous job sites.

QuikTap™ is a conductor exothermally welded to a coupling (either compression or threaded) on one end. The other end of the conductor can have various solutions, such as a; blank, another QuikTap™, ground bar, or fence clamp. For lightning protection systems LP conductors are used.

The length is specified by the customer.

Features and Benefits:

- Irreversible connection no maintenance
- No need to weld in the field
- No burn permit needed
- Perfect for volatile or hazardous jobsites
- Pigtail conductor lengths available from 1' - 995'
- Compatible with all ground rod types & configurations
- Available with threaded or compression
- Doesn't require installation driving head
- Can be used for lightning protection systems
- Quick and easy to install

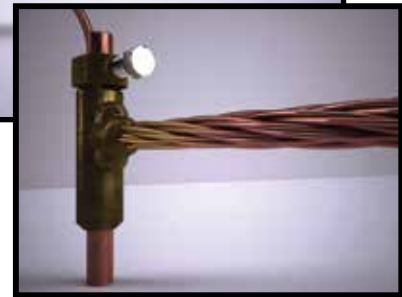

QuikTap™ for Grounding Grid Applications

QuikTap™ is designed to allow the installer to stack multiple QuikTaps onto each other. This allow the installer to direct the conductors in various directions off of the ground rod. See figure 1 and 2 in the catalog number chart page 171

QuikTap™ for Lightning Protection

QuikTap™ for lightning protection uses LP conductors to connect the lightning protection system to the grounding grid. See figure 1 and 2 in the catalog number chart page 171

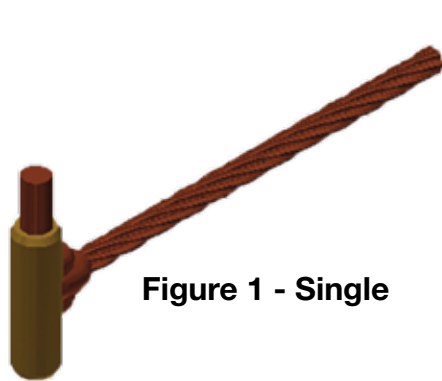

Figure 1 - Single

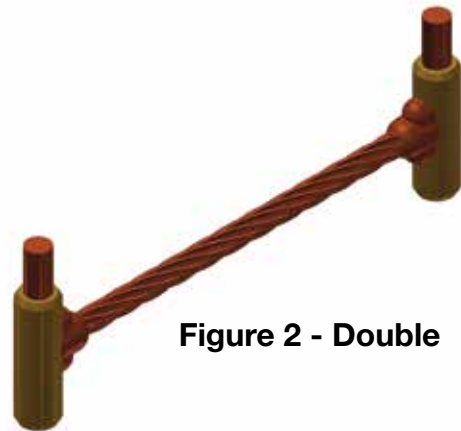

Figure 2 - Double



QuikTap™ stacked for multiple direction application.

GROUNDING PRODUCTS

QUIKTAP™

QuikTap™ for Grounding ground/Bus Bars Applications

QuikTap™ is used with a ground bar exothermically welded to the opposite end to allow lug bonds to be attached to the grounding grid. See figure 3 in the catalog number chart page 171



Figure 3 - Single to Ground Bar



Section 8
Grounding Products

QuikTap™ for Fencing Applications

When you need to ground your fence to ensure sufficient electrical contact for both ground fault and lightning current. See figure 4 in the catalog number chart page 171



Figure 4 - Single to Pipe Clamp

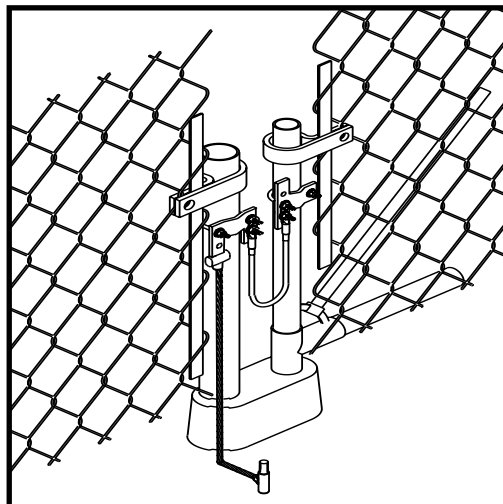

QuikTap™ Catalog Numbers

When determining your catalog number replace the †‡ with the necessary length of conductor in the chart to the right.

Catalog #	Description	Figure
38-7958-†‡	1/2" QuikTap™ (Single) X 2/0 Stranded	1
38-7959-†‡	1/2" QuikTap™ (Single) X 4/0 Stranded	1
38-7960-†‡	1/2" QuikTap™ (Double) X 2/0 Stranded	2
38-7961-†‡	1/2" QuikTap™ (Double) X 4/0 Stranded	2
38-7962-†‡	1/2" QuikTap™ (Single) X 2/0 Stranded To Ground Bar	3
38-7963-†‡	1/2" QuikTap™ (Single) X 4/0 Stranded To Ground Bar	3
38-7964-†‡	5/8" QuikTap™ (Single) X 2/0 Stranded	1
38-7965-†‡	5/8" QuikTap™ (Single) X 4/0 Stranded	1
38-7966-†‡	5/8" QuikTap™ (Double) X 2/0 Stranded	2
38-7967-†‡	5/8" QuikTap™ (Double) X 4/0 Stranded	2
38-7968-†‡	5/8" QuikTap™ (Single) X 2/0 Stranded To Ground Bar	3
38-7969-†‡	5/8" QuikTap™ (Single) X 4/0 Stranded To Ground Bar	3
38-7970-†‡	3/4" QuikTap™ (Single) X 2/0 Stranded	1
38-7971-†‡	3/4" QuikTap™ (Single) X 4/0 Stranded	1
38-7972-†‡	3/4" QuikTap™ (Double) X 2/0 Stranded	2
38-7973-†‡	3/4" QuikTap™ (Double) X 4/0 Stranded	2
38-7974-†‡	3/4" QuikTap™ (Single) X 2/0 Stranded To Ground Bar	3
38-7975-†‡	3/4" QuikTap™ (Single) X 4/0 Stranded To Ground Bar	3
38-7976-†‡	1" QuikTap™ (Single) X 2/0 Stranded	1
38-7977-†‡	1" QuikTap™ (Single) X 4/0 Stranded	1
38-7978-†‡	1" QuikTap™ (Double) X 2/0 Stranded	2
38-7979-†‡	1" QuikTap™ (Double) X 4/0 Stranded	2
38-7980-†‡	1" QuikTap™ (Single) X 2/0 Stranded To Ground Bar	3
38-7981-†‡	1" QuikTap™ (Single) X 4/0 Stranded To Ground Bar	3
38-7982-†‡	1/2" QuikTap™ (Single) X 36-7562-00 LP Class I Cable	1
38-7983-†‡	5/8" QuikTap™ (Single) X 36-7562-00 LP Class I Cable	1
38-7984-†‡	3/4" QuikTap™ (Single) X 36-7562-00 LP Class I Cable	1
38-7985-†‡	1" QuikTap™ (Single) X 36-7562-00 LP Class I Cable	1
38-8201-†‡	5/8" QuikTap™ (Single) X #6 Solid To 3/4"-1 1/4" Pipe Clamp	4
38-8202-†‡	5/8" QuikTap™ (Single) X #6 Solid To 1 1/2"-2" Pipe Clamp	4
38-8203-†‡	5/8" QuikTap™ (Single) X #6 Solid To 2 1/2"-3" Pipe Clamp	4
38-8204-†‡	5/8" QuikTap™ (Single) X #6 Solid To 3 1/2"-4" Pipe Clamp	4
38-8205-†‡	5/8" QuikTap™ (Single) X #6 Solid To 5"-6" Pipe Clamp	4
38-8206-†‡	3/4" QuikTap™ (Single) X #6 Solid To 3/4"-1 1/4" Pipe Clamp	4
38-8207-†‡	3/4" QuikTap™ (Single) X #6 Solid To 1 1/2"-2" Pipe Clamp	4
38-8208-†‡	3/4" QuikTap™ (Single) X #6 Solid To 2 1/2"-3" Pipe Clamp	4
38-8209-†‡	3/4" QuikTap™ (Single) X #6 Solid To 3 1/2"-4" Pipe Clamp	4
38-8210-†‡	3/4" QuikTap™ (Single) X #6 Solid To 5"-6" Pipe Clamp	4
38-8221-†‡	5/8" QuikTap™ (Single) X 4/0 Stranded To 3/4"-1 1/4" Pipe Clamp	4
38-8222-†‡	5/8" QuikTap™ (Single) X 4/0 Stranded To 1 1/2"-2" Pipe Clamp	4
38-8223-†‡	5/8" QuikTap™ (Single) X 4/0 Stranded To 2 1/2"-3" Pipe Clamp	4
38-8224-†‡	5/8" QuikTap™ (Single) X 4/0 Stranded To 3 1/2"-4" Pipe Clamp	4
38-8225-†‡	5/8" QuikTap™ (Single) X 4/0 Stranded To 5"-6" Pipe Clamp	4
38-8226-†‡	3/4" QuikTap™ (Single) X 4/0 Stranded To 3/4"-1 1/4" Pipe Clamp	4
38-8227-†‡	3/4" QuikTap™ (Single) X 4/0 Stranded To 1 1/2"-2" Pipe Clamp	4
38-8228-†‡	3/4" QuikTap™ (Single) X 4/0 Stranded To 2 1/2"-3" Pipe Clamp	4
38-8229-†‡	3/4" QuikTap™ (Single) X 4/0 Stranded To 3 1/2"-4" Pipe Clamp	4
38-8230-†‡	3/4" QuikTap™ (Single) X 4/0 Stranded To 5"-6" Pipe Clamp	4

† = Feet	‡ = Feet
0	0
1	1
2	2
3	3
4	4
5	5
6	6
7	7
8	8
9	9
	A = 0
	B = 5
	C = 10
	D = 15
	E = 20
	F = 25
	G = 30
	H = 35
	J = 40
	K = 45
	L = 50
	M = 55
	N = 60
	P = 65
	R = 70
	S = 75
	T = 80
	V = 85
	W = 90
	X = 95

EXAMPLES

38-7958-†‡ : † = 1 ft., ‡ = 5 ft.

38-7958-15 = 1/2" QuikTap™ (Single) with 15' long 2/0 Stranded Pigtail

38-8209-†‡ : † = 1 ft., F = 25 ft.

38-8209-1F = 3/4" QuikTap™ (Single) with 125 foot long #6 Solid To 3 1/2"-4" Pipe Clamp

GROUND RODS



Copper Bonded Ground Rods

Manufactured from high tensile low carbon steel by molecularly bonding 99.9% pure electrolytic copper. These ground rods are UL-467 listed and have a minimum copper thickness of 10 mils.

Copper Bonded Ground Rods			
Catalog #	Rod Dia	Length	Copper Thickness
38-4635-01	5/8"	8'	10 mils
38-4635-00	5/8"	10'	10 mils
38-4635-03	3/4"	8'	10 mils
38-4635-04	3/4"	10'	10 mils

Other sizes available upon request



Sectional Copper Bonded Ground Rods

Manufactured from high tensile low carbon steel by molecularly bonding 99.9% pure electrolytic copper. These ground rods are UL-467 listed and have a minimum copper thickness of 10 mils. The rods are threaded by rolling threading process.

Copper Bonded Ground Rods				
Catalog #	Rod Dia (in)	Length (ft)	Thread Dia	Copper Thickness
38-4635-71	5/8"	8'	5/8"	10 mils
38-4635-21	5/8"	10'	5/8"	10 mils
38-4635-24	3/4"	10'	3/4"	10 mils

Other sizes available upon request



GROUND ROD ACCESSORIES

Threaded Coupling

Threaded couplings are made of high grade material for higher strength with counter bores for protecting the rod threads from damage.

Threaded Coupling, Bronze	
Catalog #	Rod Dia
38-6313-02	5/8"
38-6313-04	3/4"



UL Listed

Compression Coupling

Compression couplings are made of high grade material for higher strength.

Compression Coupling, Bronze	
Catalog #	Rod Dia
38-6313-09	5/8"
38-6313-08	3/4"

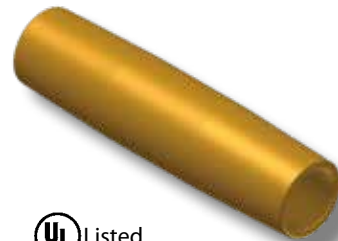

UL Listed

Driving Stud for Threaded Coupling

Suitable for both manual and power hammering. Can be reused.

Driving Stud	
Catalog #	Thread Dia
38-6607-03	5/8"
38-6607-04	3/4"



Ground Rod Clamp

These clamps are used for joining ground rods to copper cables.

Ground Rod Clamp	
Catalog #	Rod Dia (in)
38-6598-02	1/2" - 5/8"
38-6598-03	3/4"



GROUNDING PRODUCTS

UL LISTED CHEMICAL GROUND ROD KITS VERTICAL

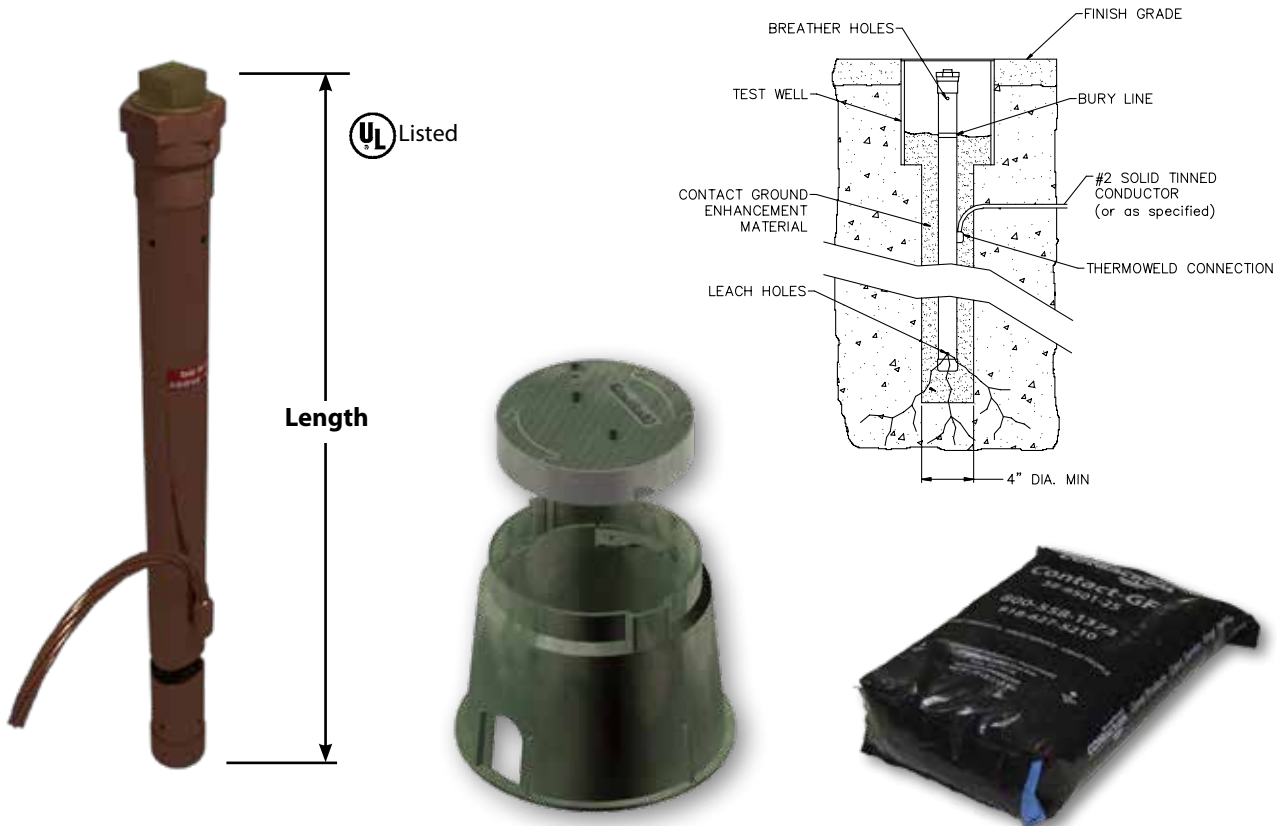

Section 8
Grounding Products

Catalog Number	Length	Inspection Well	Contact GF 25# Bag	Pigtail
38-6050-01	5'	No	~	5' - 4/0 STR
38-6050-31	5'	Yes	2	5' - 4/0 STR
38-6050-02	10'	No	~	5' - #2 SOL (Tinned)
38-6050-32	10'	Yes	4	5' - #2 SOL (Tinned)
38-6050-03	10'	No	~	5' - 2/0 STR
38-6050-33	10'	Yes	4	5' - 2/0 STR
38-6050-04	10'	No	~	5' - 4/0 STR
38-6050-34	10'	Yes	4	5' - 4/0 STR
38-6050-05	20'	No	~	5' - #2 SOL (Tinned)
38-6050-35	20'	Yes	8	5' - #2 SOL (Tinned)
38-6050-06	20'	No	~	5' - 2/0 STR
38-6050-36	20'	Yes	8	5' - 2/0 STR
38-6050-07	20'	No	~	5' - 4/0 STR
38-6050-37	20'	Yes	8	5' - 4/0 STR

• Other sizes and conductor types available. Contact the factory for details.

APPLICATION NOTES:

- Supplied Pre-Filled.
- Chemical Ground Rods are used in high resistivity soil conditions and when low resistance ground electrode systems are critical.
- Conductor is welded 18" down from the top.
- Outside diameter of copper tube is 2-1/8".

UL LISTED CHEMICAL GROUND ROD KITS HORIZONTAL L-SHAPED

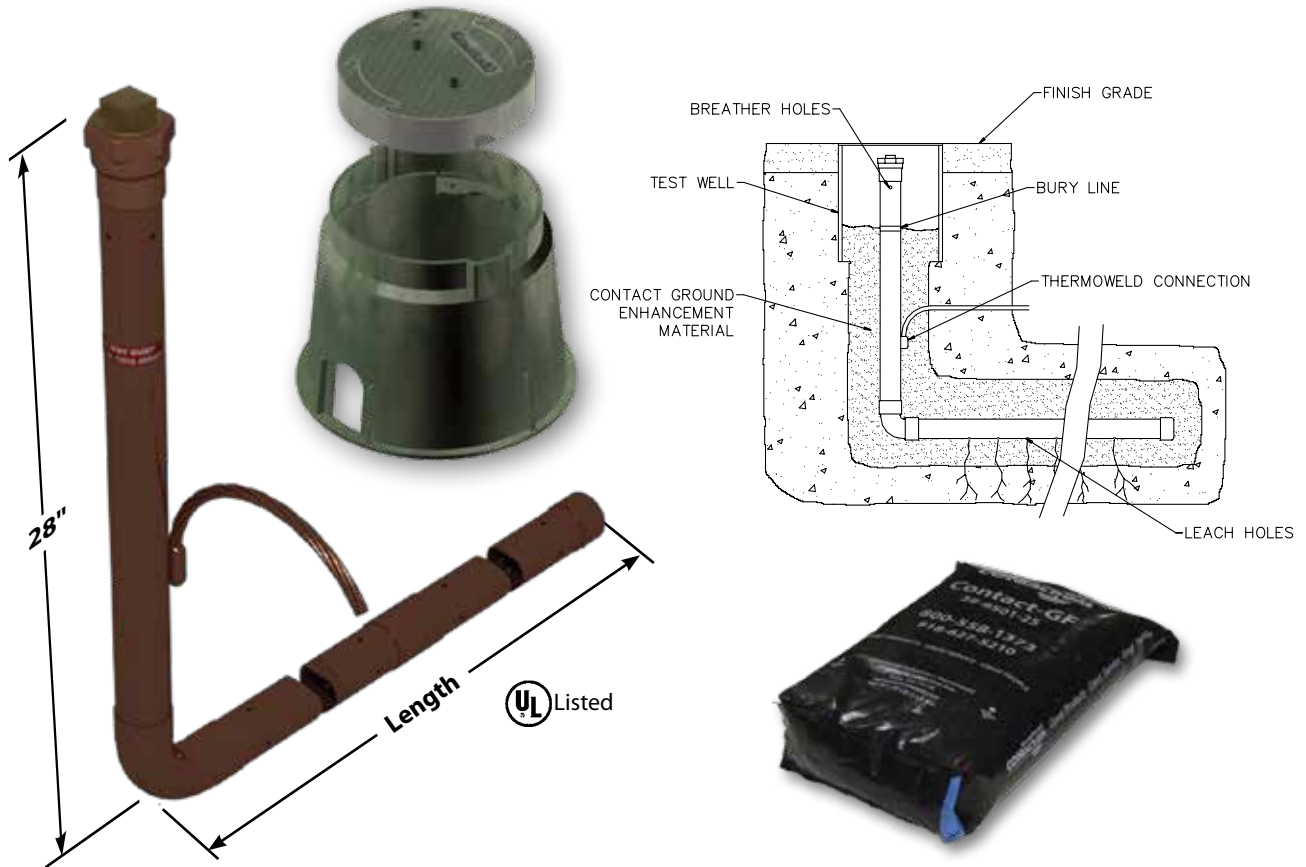

Catalog Number	Length	Inspection Well	Contact GF 25# Bag	Pigtail
38-6051-02	2' X 10'	No	~	5' - #2 SOL (Tinned)
38-6051-32	2' X 10'	Yes	4	5' - #2 SOL (Tinned)
38-6051-03	2' X 10'	No	~	5' - 2/0 STR
38-6051-33	2' X 10'	Yes	4	5' - 2/0 STR
38-6051-04	2' X 10'	No	~	5' - 4/0 STR
38-6051-34	2' X 10'	Yes	4	5' - 4/0 STR
38-6051-05	2' X 20'	No	~	5' - #2 SOL (Tinned)
38-6051-35	2' X 20'	Yes	8	5' - #2 SOL (Tinned)
38-6051-06	2' X 20'	No	~	5' - 2/0 STR
38-6051-36	2' X 20'	Yes	8	5' - 2/0 STR
38-6051-07	2' X 20'	No	~	5' - 4/0 STR
38-6051-37	2' X 20'	Yes	8	5' - 4/0 STR

- Other sizes and conductor types available. Contact the factory for details.

APPLICATION NOTES:

- Supplied Pre-Filled.
- Chemical Ground Rods are used in high resistivity soil conditions and when low resistance ground electrode systems are critical.
- L-shaped Chemical ground rods are used when proper depth cannot be achieved due to physical conditions such as bedrock.
- Conductor is welded 18" down from the top.
- Outside diameter of copper tube is 2-1/8".



CONTACT-GM

CONTACT-GF

thermOweld® **CONTACT-GF** is an economical solution for areas with very difficult grounding issues.

CONTACT-GF is highly conductive in a wet or dry application and does not require moisture to lower the resistance of your grounding system.

CONTACT-GF contains a corrosion inhibitor which forms a film on copper creating a barrier against corrosion.

CONTACT-GF can be poured in dry or pumped in slurry form. No tamping required. It is very contractor friendly. No special tools required.

Type	Part #
CONTACT - GF 25lb	38-6501-25
CONTACT - GF 50lb	38-6501-50

CONTACT-GF Advantages:

- Easy to install
- Electrically Conductive
- Environmentally Friendly
- Will not leech into the ground
- Positive low resistance, electrical connection to earth
- Does not contain any hazardous chemicals
- Compatible with all copper grounding systems
- Contains a corrosion inhibitor to protect copper
- Will not expand or shrink
- Not affected by freezing
- Excellent shelf life
- Typical resistivity <10 Ohm-cm



CONTACT-GF Material Required Per Linear Foot of Trench

DEPTH of CONTACT-GF (Inches)	WIDTH OF TRENCH (Inches)										
	4	6	8	10	12	14	16	18	20	22	24
2	4.1	6.2	8.1	10.1	12.1	14.1	16.2	18.2	20.2	22.2	24.2
3	6.2	9.3	12.1	15.2	18.2	21.2	24.2	27.3	30.3	33.3	36.4
4	8.2	12.3	16.2	20.2	24.2	28.3	32.3	36.4	40.4	44.5	48.5
5	10.3	15.4	20.2	25.3	30.3	35.4	40.4	45.5	50.5	55.6	60.6
6	12.3	18.5	24.2	30.3	36.4	42.4	48.5	54.6	60.6	66.7	72.7
7	14.4	21.6	28.3	35.4	42.4	49.5	56.6	63.7	70.7	77.8	84.9
8	16.4	24.7	32.3	40.4	48.5	56.0	64.7	72.7	80.8	88.9	97.0
9	18.5	27.8	36.4	45.5	54.6	63.7	72.7	81.8	90.9	100.0	109.1
10	20.6	30.8	40.4	50.5	60.6	70.7	80.8	90.9	101.0	111.1	121.2

To calculate the lbs of material required to-fill a trench

1. Determine desired thickness
2. Move to the right until you are under the known width of the trench. This number will be the weight of the material lbs/linear ft.
3. Take this number and multiply by the length of the trench in feet. Your answer will be the amount of **CONTACT-GF** material required to fill the trench to the desired level in lbs.

Example:

Depth of CONTACT-GF	=	6 inches
Width of trench	=	18 inches
Length of trench	=	25 ft.
Answer	=	1,365 lbs of CONTACT-GF

1,365 lbs. = 54.6 lbs* per linear ft or 28 (50 lb) bags of **CONTACT-GF**

* From chart above.

CONTACT-GM

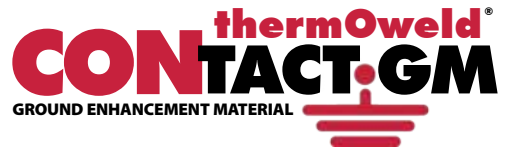

CONTACT-GS

Certain applications require a permanent hardening grounding material. thermOweld® **CONTACT-GS** is the product of choice.

CONTACT-GS is compatible with all standard copper grounding systems. It is an economical solution to difficult grounding issues in hard to deal with areas.

CONTACT-GS is manufactured from environmentally safe material and is extremely stable when mixed with water or exposed to moisture.

CONTACT-GS attains the hardening characteristics of cement while retaining its highly conductive properties.

CONTACT-GS will remain highly conductive during a drought or when exposed to extremely low temperature.

Since **CONTACT-GS** does not have any shrinkage or expansion properties it will remain in constant **CONTACT** with the earth.

CONTACT-GS can be poured in dry or pumped in slurry form. No tamping required. It is very contractor friendly. No special tools required.

CONTACT-GS Advantages:

- Easy to install
- Will attain a hardened state
- Electrically Conductive
- Environmentally Friendly
- Will not leech into the ground
- Positive low resistance, electrical connection to earth
- Does not contain any hazardous chemicals
- Compatible with all copper grounding systems
- Will not expand or shrink
- Not affected by freezing
- Excellent shelf life
- Typical resistivity <10 Ohm-cm



Type	Part #
CONTACT - GS 25lb	38-6502-25
CONTACT - GS 50lb	38-6502-50

CONTACT-GS Material Required Per Linear Foot of Trench

DEPTH of CONTACT-GS (Inches)	Width of Trench (Inches)										
	4	6	8	10	12	14	16	18	20	22	24
2	3.6	5.4	7.2	9.0	10.8	12.6	14.4	16.2	18.0	19.7	21.5
3	5.4	8.1	10.8	13.5	16.2	18.8	21.5	24.2	26.9	29.6	32.3
4	7.2	10.8	14.4	18.0	21.5	25.1	28.7	32.3	35.9	39.5	43.1
5	9.0	13.5	18.0	22.4	26.9	31.4	35.9	40.4	44.9	49.4	53.9
6	10.8	16.3	21.5	26.9	32.3	37.7	43.1	48.5	53.9	59.2	64.6
7	12.6	19.0	25.1	31.4	37.7	44.0	50.3	56.5	62.8	69.1	75.4
8	14.4	21.7	28.7	35.9	43.1	50.3	57.4	64.6	71.8	79	86.2
9	16.3	24.4	32.3	40.4	48.5	56.5	64.6	72.7	80.8	88.9	96.9
10	18.1	27.1	35.9	44.9	53.9	62.8	71.8	80.8	89.8	98.7	107.7

To calculate the lbs of material required to-fill a trench

1. Determine desired thickness
2. Move to the right until you are under the known width of the trench. This number will be the weight of the material lbs/linear ft.
3. Take this number and multiply by the length of the trench in feet. Your answer will be the amount of **CONTACT-GS** material required to fill the trench to the desired level in lbs.

Example:

Depth of CONTACT-GS	=	6 inches
Width of trench	=	18 inches
Length of trench	=	25 ft.
Answer	=	1,212 lbs of CONTACT-GS

1,212 lbs. = 48.5 lbs* per linear ft. or 24 (50 lb) bags of **CONTACT-GF**

* From chart above.

GROUNDING PRODUCTS

GROUND ACCESS WELLS

Light Duty Ground Access Well

Catalog Number	Diameter (in)	Length (in)	Cover Type
PE6AHDH00L74	6	9	HDPE
PE9AHDH00L74	9	10	HDPE
PE10HDH00L74	10	18.875	HDPE
PE10UPH00009	10	18.25	Steel
38-8130-02	10	19	Steel with Steel/PC Ring



Access Well with Cast Iron Cover

Catalog Number	Diameter	Length	Cover Type
38-6344-12*	12"	12"	Cast Iron
38-6343-36	10"	36"	Cast Iron
38-6343-42	10"	42"	Cast Iron

- Schedule 80 PVC well.
- Four 27" slots allow for ground electrode connections to be made before installation of test well. * No Slots
- Cast iron cover fits into cast iron ring for extra support.



Heavy Duty Well with Cast Iron Cover

Catalog Number	Diameter	Length	Cover Type
38-6344-18	12"	18"	Cast Iron
38-6344-24	12"	24"	Cast Iron
38-6344-30	12"	30"	Cast Iron
38-6344-36	12"	36"	Cast Iron

- 12" diameter Schedule 80 PVC well.
- Cast iron cover fits into cast iron ring for extra support.
- Tier 22: Driveway, Parking lot, and off-roadway applications subject to occasional non deliberate heavy vehicular traffic.



Contact thermOweld for other options

APPLICATION NOTES:

- Provides ready access to ground electrode for testing and inspection purposes.
- To prevent displacement by frost, the access well must be longer than the frost line is deep.

GROUNDING PRODUCTS

GROUND ACCESS WELLS

thermOweld® polymer concrete enclosures meet or exceed the test provisions of ANSI/SCTE 77 2013.

Testing requirements for ANSI/SCTE 77 2013 are:

- Three-Position Load testing to simulate actual application performance
- UV Degradation per ASTM G-154
- Fire Resistance per RUS 7CFR 1755.919 (PE-91)
- Chemical Resistance per ASTM D-543
- Water Absorption per ASTM D-570
- Impact Resistance per ASTM D2444
- Accelerated Service per ASTM D-756, procedure E

Stackable Access Wells

Stackable access wells are designed so they can be stacked to increase the well depth. Used for a variety of purposes, such as a splice box, pull box, equipment enclosure, or for any application requiring easy access to an underground service. The straight sides allow for easy adjustment of the box should the grade level change.



Rectangular Stackable Access Well

Catalog Number	Width	Length	Depth	Cover Type	Tier
38-8175-00	13"	24"	18"	Polymer Concrete	15
38-8171-00	13"	24"	12"	Polymer Concrete	15

Other sizes and tiers available upon request.

Tier 15: Driveway, parking lot, and off-roadway applications subject to occasional non-deliberate heavy vehicular traffic.

Square Stackable Access Well

Catalog Number	Width	Length	Depth	Cover Type	Tier
38-8131-00	8"	8"	12"	Polymer Concrete	15
38-8132-00	8"	8"	18"	Polymer Concrete	15
38-8145-00	12"	12"	12"	Polymer Concrete	15
38-8147-00	12"	12"	24"	Polymer Concrete	15

Other sizes and tiers available upon request.

Tier 15: Driveway, parking lot, and off-roadway applications subject to occasional non-deliberate heavy vehicular traffic.



GROUND ACCESS WELLS

Nestable Access Wells

Nestable access wells are designed for compact storage and are excellent for service box assemblies and offer flared design to prevent frost heave.

Nestable Access Well

Catalog Number	Width	Length	Depth	Cover Type	Tier
38-8166-00	12"	12"	24"	Polymer Concrete	15

Other sizes and tiers available upon request.

Tier 15: Driveway, parking lot, and off-roadway applications subject to occasional non-deliberate heavy vehicular traffic.



Cylindrical Access Wells

Cylindrical access wells prevent the enclosure cover from falling into the box.

Cylindrical Access Well

Catalog Number	Diameter	Depth	Cover Type	Tier
38-8185-00	27"	36"	Polymer Concrete	8

Other sizes and tiers available upon request.

Tier 8: Sidewalk applications with a safety factor for non-deliberate vehicular traffic.



BUS BARS/GROUND BARS

Series CB, TCB and SSB

Proper bonding is essential to create an isopotential plane between service grounds and equipment during fault and transient conditions. This isopotential plane provides a near zero voltage differential and serves to protect people and equipment during these events. The most popular bonding product in use today is the ground bar or bonding bar.

thermOweld®'s ground bars and bus bars are UL approved and produced on our state-of-the-art automated production line to give you thermOweld's famous rapid shipment and excellent quality. Virtually endless sizes and configurations, hole and slot patterns, unplated copper or tin plated, as well as stainless steel and other options with and without brackets and insulators. Customers worldwide are taking advantage of thermOweld's ground bars for a wide range of applications and unique requirements, from telecom sites to energy facilities. Please contact us with your specific needs!

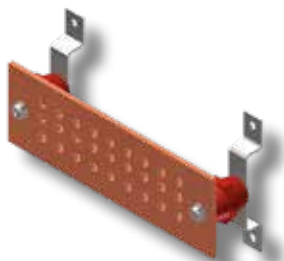

CB14412JK

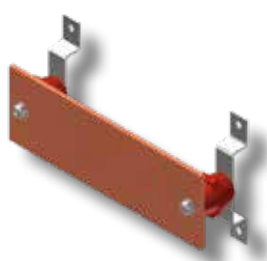

CB14412NK

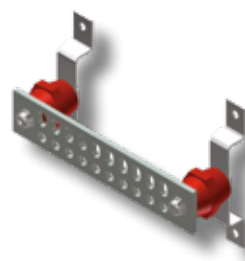

TCB14210PK

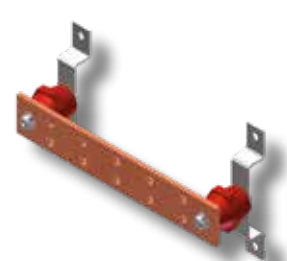

CB14212BK

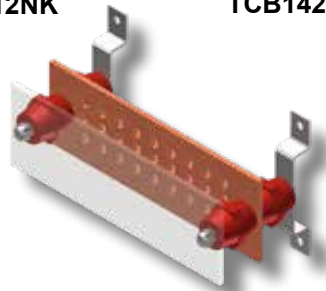

CB14412JP:
Ground Bar with Plexiglas Cover

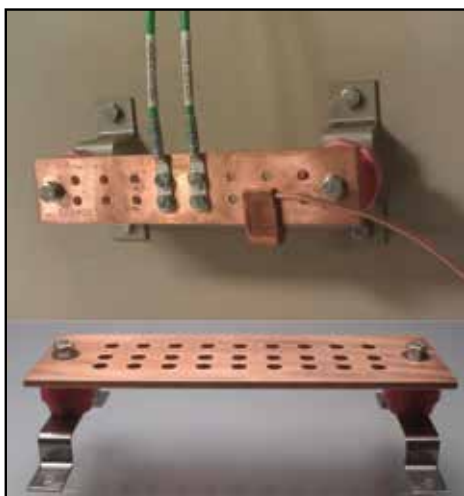

Call Today Ship Today!
Same Day Service
GROUND BARS BUS BARS

Catalog Number	Hole Pattern	Tinned	Bar Size	# of Holes
CB14412JK	Pattern J w/ Insulators & Brackets	No	1/4" X 4" X 12"	27
CB14412M	Pattern M	No	1/4" X 4" X 12"	48
CB14412MK	Pattern M w/ Insulators & Brackets	No	1/4" X 4" X 12"	48
CB14210P	Pattern P	No	1/4" X 2" X 10"	26
CB14210PK	Pattern P w/ Insulators & Brackets	No	1/4" X 2" X 10"	26
CB14212P	Pattern P	No	1/4" X 2" X 12"	26
CB14212PK	Pattern P w/ Insulators & Brackets	No	1/4" X 2" X 12"	26

GROUND BAR HOLE PATTERNS

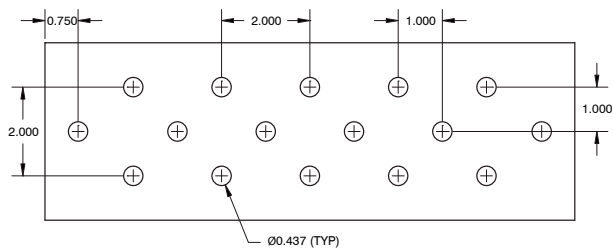

Pattern A

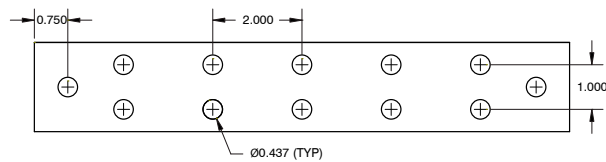

Pattern B

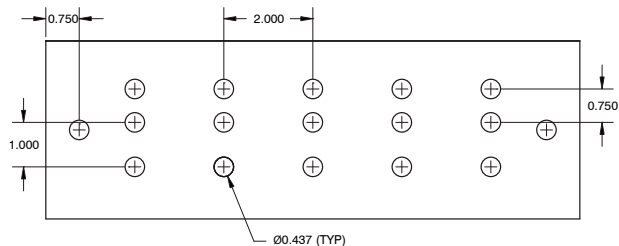

Pattern C

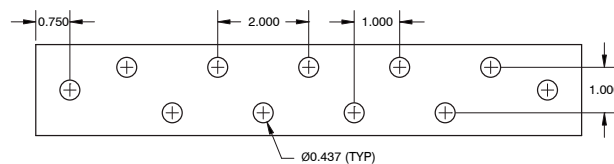

Pattern D

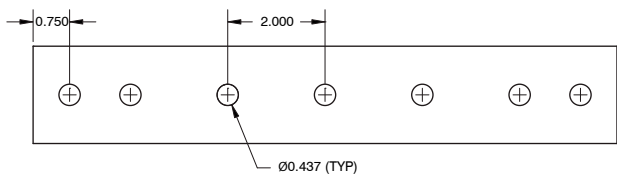

Pattern E

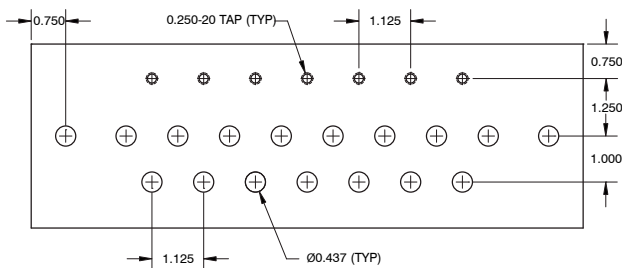

Pattern F

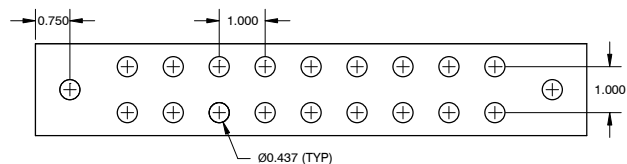

Pattern G

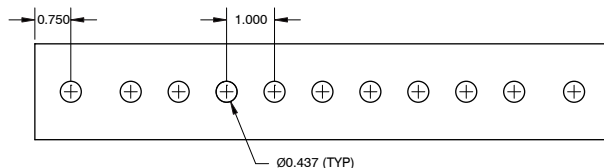

Pattern H

NOTES:

- All holes are 7/16" unless specified differently. To order threaded holes, specify hole size. The standard tapped hole size is 1/4-20 unless specified differently.
- Above bar patterns represent a 12" ground bar.
- All bars are available with electro-tin plating.

GROUND BAR HOLE PATTERNS

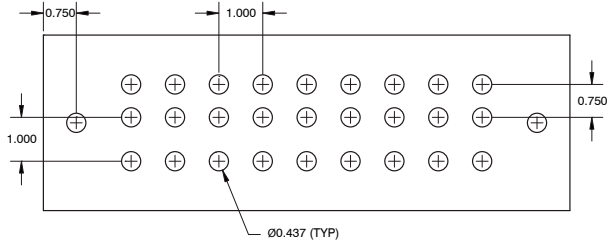

Pattern J

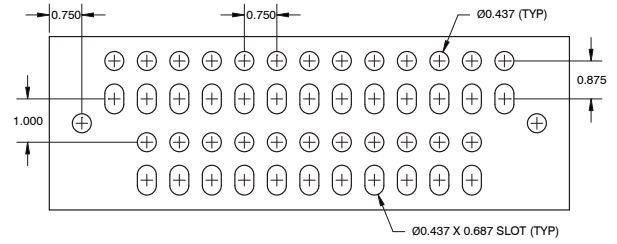

Pattern M

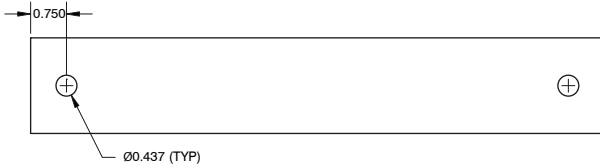

Pattern N

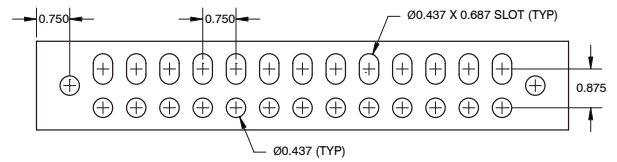

Pattern P

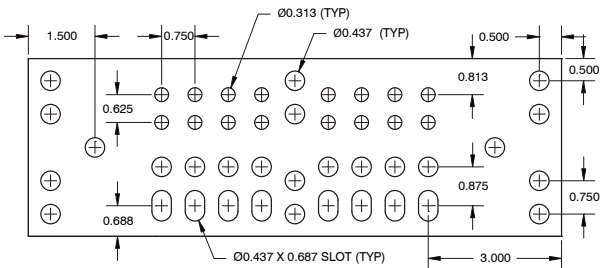

Pattern Q

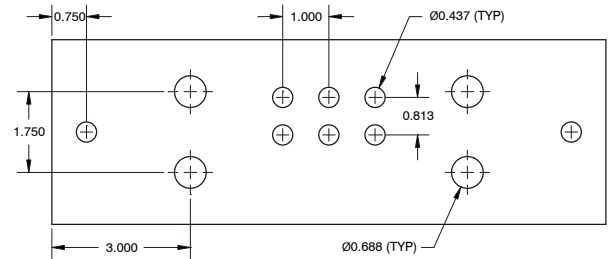

Pattern R

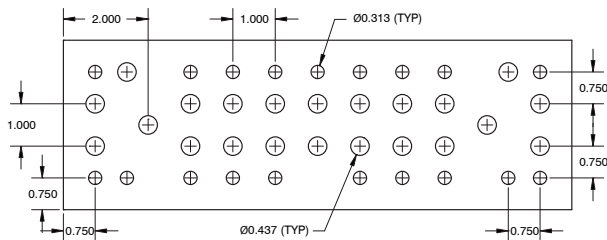

Pattern T

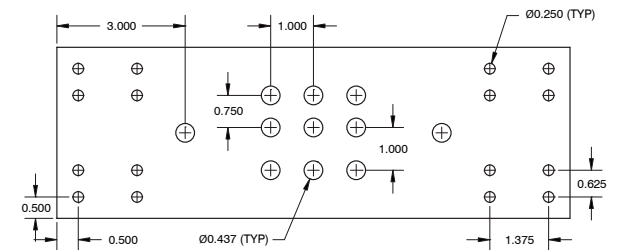

Pattern V

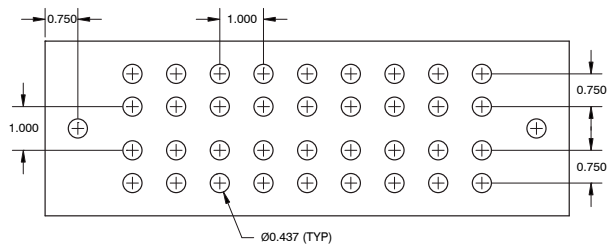

Pattern W

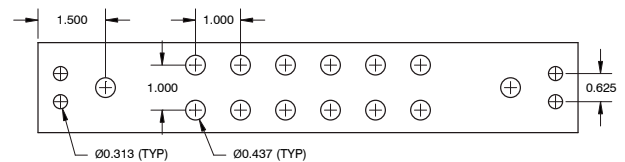

Pattern X

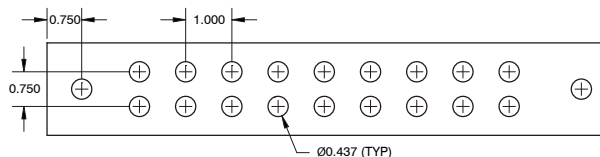

Pattern Z

NOTE: For telecom ground bar patterns (Pattern S, BICSI) See pages 184-185

GROUNDING PRODUCTS

TELECOM GROUND BAR HOLE PATTERNS 2" BARS

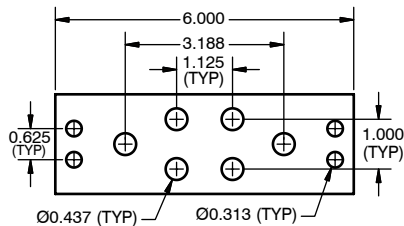

CB1426S

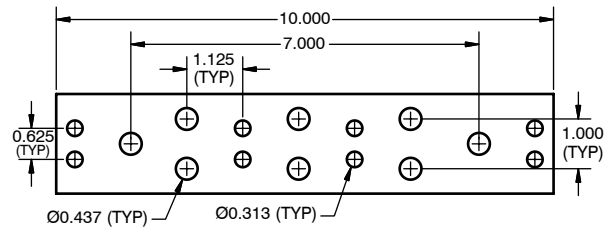

CB14210S

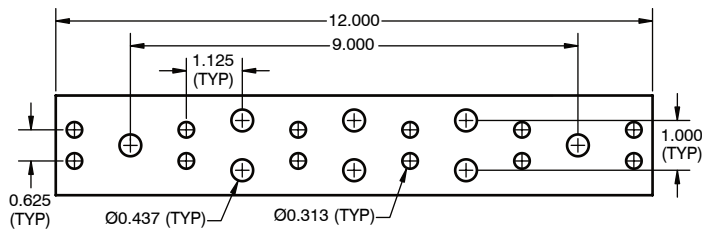

CB14212S

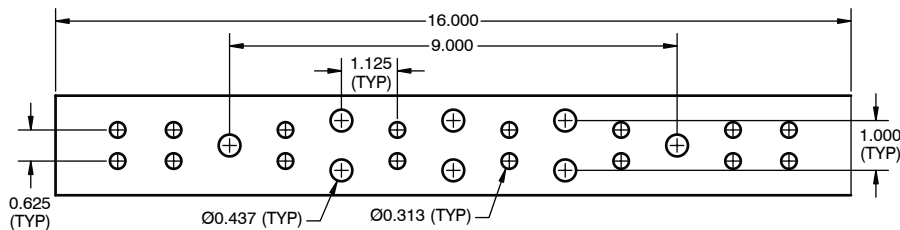

CB14216S

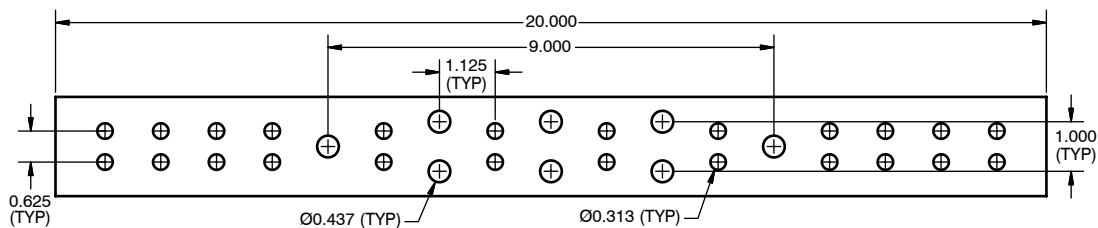

CB14220S

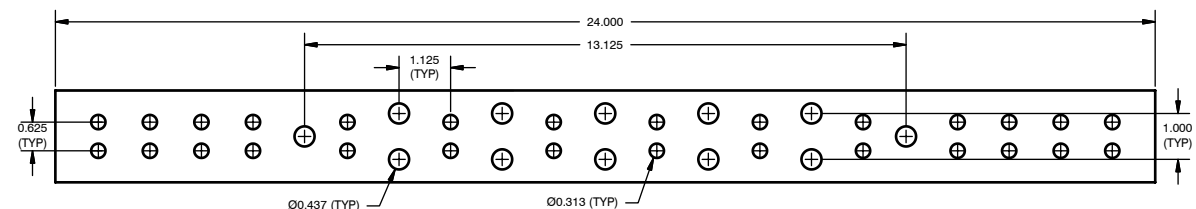

CB14224S

Catalog number shown is for the bar only if a kit is need add a K to the end of the catalog number.

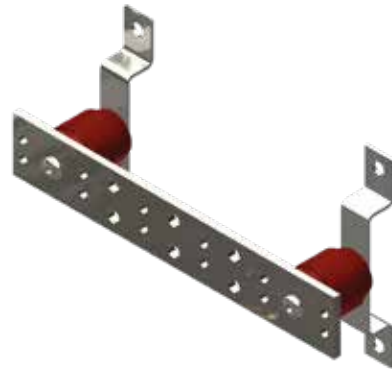

TCB14212SK

TELECOM GROUND BAR HOLE PATTERNS 4" BARS

Catalog number shown is for the bar only if a kit is need add a K to the end of the catalog number.

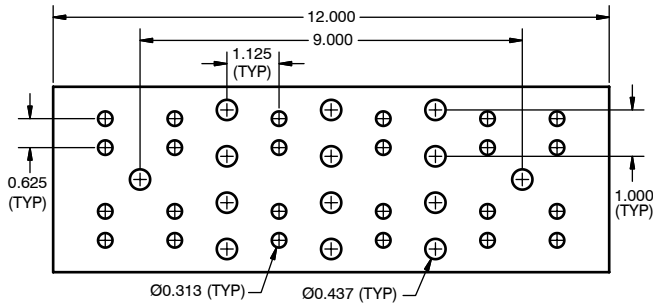

CB14412S

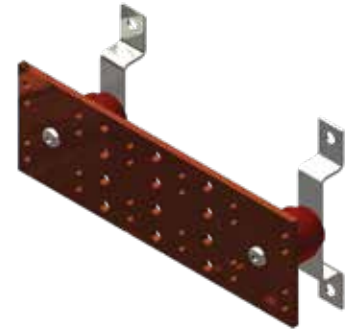

CB14412SK

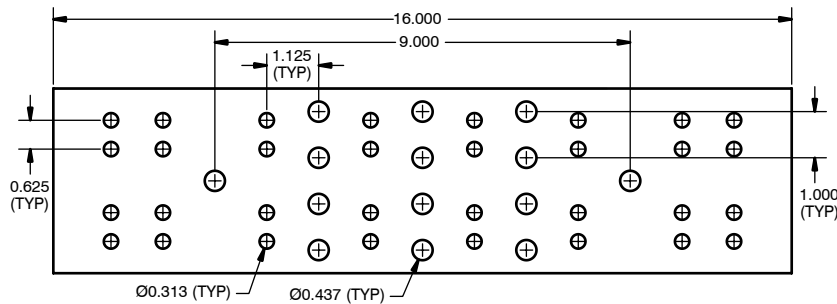

CB14416S

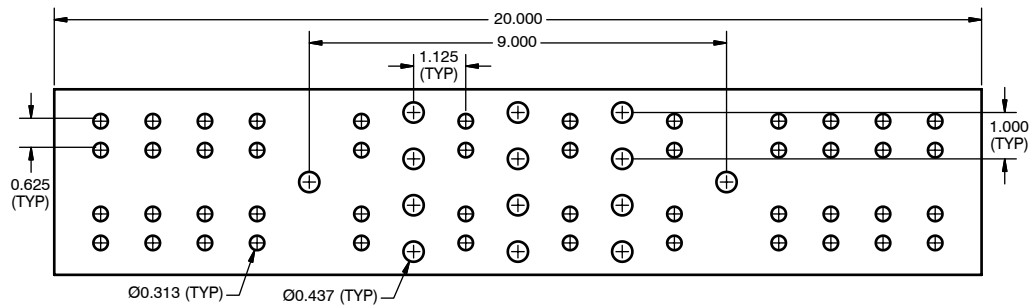

CB14420S

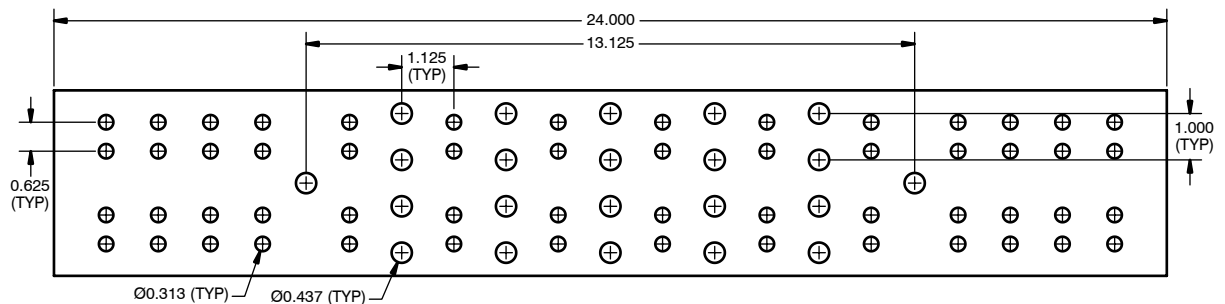

CB14424S

GROUND BARS

GROUND BAR NUMBERING SYSTEM

Below is a guide on how to understand thermOweld's ground bar numbering system. Each digit of the catalog number represents specific details of our ground bars. Please note that other sizes are available. Contact thermOweld for details.

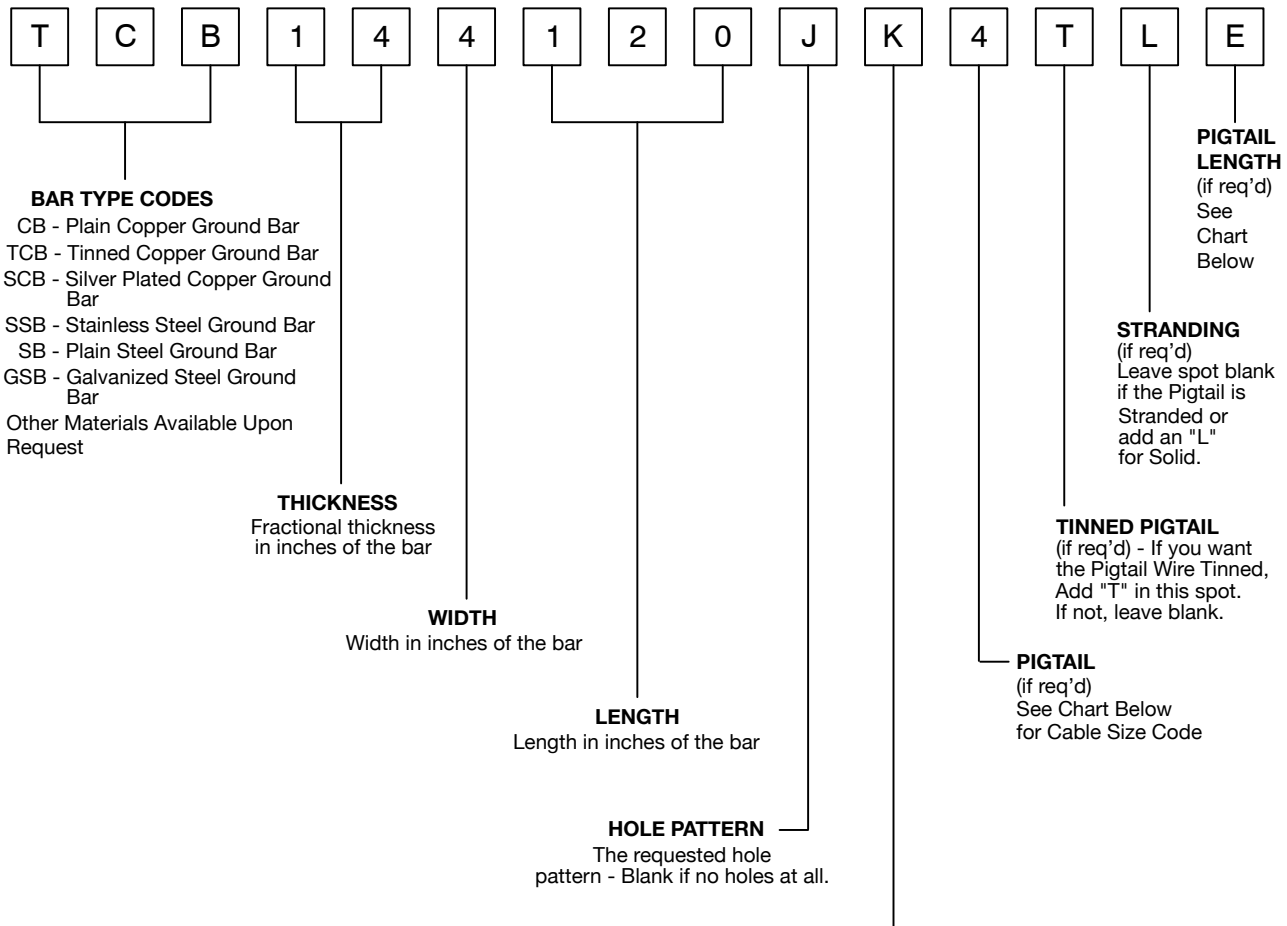

Pigtail Cable Size Chart

Pigtail No.	Size
1	#6
2	#4
3	250 mcm
4	#2
5	#1
6	1/0
7	2/0
8	500 mcm
9	4/0

Pigtail Cable Length Chart

Pigtail Length	Length in Feet*
A	2'
B	5'
C	10'
D	15'
E	20'
F	25'
G	30'
H	35'

*Custom lengths available upon request, contact thermOweld for details.

ASSEMBLY TYPE CODES

- K = Brackets & Insulators
- B = Brackets Only
- I = Insulators Only
- C = Beam Clamps & Insulators
- A = Brackets & Insulators with Anti-Theft Bolts
- P = Plexiglass Cover (Includes Brackets & Insulators)
- T = TMGB (Telecom Main Ground Bar) Plexiglass Cover (Includes Brackets & Insulators)
- M = MGB (Main Ground Bar) Plexiglass Cover (Includes Brackets & Insulators)
- U = Universal (Includes Brackets, Insulators, Beam Clamps & Drive-In Anchors)
- Blank for Nothing (no Brackets or Insulators- Bar Only)

GROUND BARS

Pattern "J"				
Catalog Number	Kit	Tinned	Bar Size	# of Holes
CB14412J	Bar Only	No	1/4" X 4" X 12"	27
TCB14412J		Yes	1/4" X 4" X 12"	27
CB14412JK	Bar w/ Insulators & Brackets	No	1/4" X 4" X 12"	27
TCB14412JK		Yes	1/4" X 4" X 12"	27
CB14420J	Bar Only	No	1/4" X 4" X 20"	51
TCB14420J		Yes	1/4" X 4" X 20"	51
CB14420JK	Bar w/ Insulators & Brackets	No	1/4" X 4" X 20"	51
TCB14420JK		Yes	1/4" X 4" X 20"	51
CB14424J	Bar Only	No	1/4" X 4" X 24"	63
TCB14424J		Yes	1/4" X 4" X 24"	63
CB14424JK	Bar w/ Insulators & Brackets	No	1/4" X 4" X 24"	63
TCB14424JK		Yes	1/4" X 4" X 24"	63

- Mounting holes not included in total.
- Accommodates two hole lugs spaced 3/4", 1" and 1-3/4" on center.
- 12" bar pictured. Holes are 7/16" diameter.
- Bars available electro-tin plated.
- Bars available with pigtails.
- Tamper proof bolts available.
- Plexiglas cover available.
- Other sizes available. Contact factory for details.

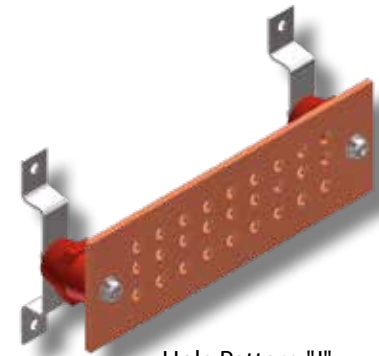

Hole Pattern "J"

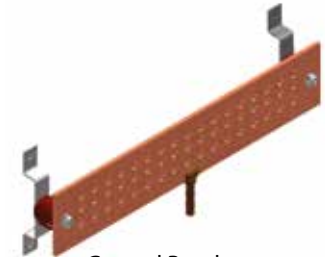

Ground Bar shown with optional pigtail.

Pattern "M"				
Catalog Number	Kit	Tinned	Bar Size	# of Holes
CB14412M	Bar Only	No	1/4" X 4" X 12"	48
TCB14412M		Yes	1/4" X 4" X 12"	48
CB14412MK	Bar w/ Insulators & Brackets	No	1/4" X 4" X 12"	48
TCB14412MK		Yes	1/4" X 4" X 12"	48
CB14420M	Bar Only	No	1/4" X 4" X 20"	88
TCB14420M		Yes	1/4" X 4" X 20"	88
CB14420MK	Bar w/ Insulators & Brackets	No	1/4" X 4" X 20"	88
TCB14420MK		Yes	1/4" X 4" X 20"	88
CB14424M	Bar Only	No	1/4" X 4" X 24"	112
TCB14424M		Yes	1/4" X 4" X 24"	112
CB14424MK	Bar w/ Insulators & Brackets	No	1/4" X 4" X 24"	112
TCB14424MK		Yes	1/4" X 4" X 24"	112

- Mounting holes not included in total.
- Accommodates two hole lugs spaced 3/4" and 1" on center.
- 12" bar pictured. Holes are 7/16" diameter and slots are 7/16" x 11/16".
- Bars available electro-tin plated.
- Tamper proof bolts available.
- Plexiglas cover available.
- Other sizes available. Contact factory for details.

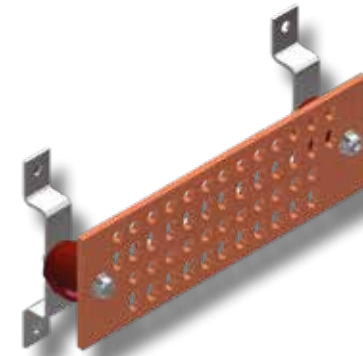

Hole Pattern "M"

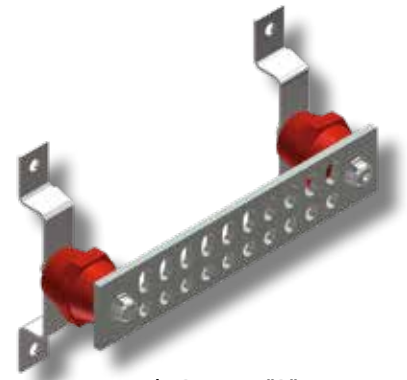

Hole Pattern "P"

Pattern "P"				
Catalog Number	Kit	Tinned	Bar Size	# of Holes
CB14212P	Bar Only	No	1/4" X 2" X 12"	26
TCB14212P		Yes	1/4" X 2" X 12"	26
CB14212PK	Bar w/ Insulators & Brackets	No	1/4" X 2" X 12"	26
TCB14212PK		Yes	1/4" X 2" X 12"	26

- Mounting holes not included in total.
- Accommodates two hole lugs spaced 3/4" and 1" on center.
- 12" bar pictured. Holes are 7/16" diameter and slots are 7/16" x 11/16".
- Bars available electro-tin plated.
- Tamper proof bolts available.
- Plexiglas cover available.
- Other sizes available. Contact factory for details.



GROUNDING PRODUCTS

STANDOFF INSULATORS - RED

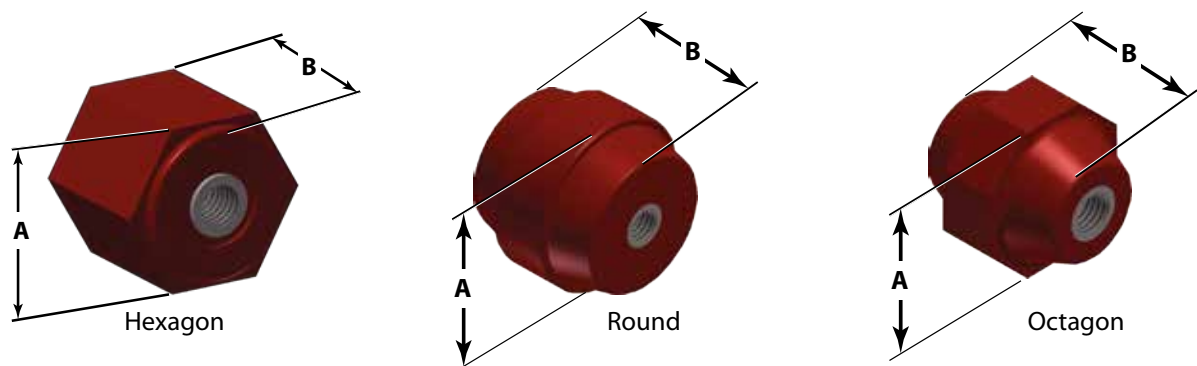

Manufactured from glass reinforced thermoset polyester.

Catalog Number	"A"	"B"	Shape	Thread Size	Voltage Rating
38-6330-00	1"	1"	Hex	1/4" - 20 X 5/16" AL	600
38-6330-01	1"	1 1/4"	Hex	1/4"-20 x 5/16" AL	600
38-6331-00	2"	1 1/2"	Octagon	1/4" - 20 X 7/16" STL	1500
38-6333-00	1 3/4"	2"	Round	3/8" - 16 X 9/16" STL	2500
38-6334-00	2"	2"	Octagon	1/2" - 13 X 5/8" STL	2500
38-6334-01	2"	2"	Octagon	3/8" - 16 X 9/16" STL	2500
38-7725-00	2"	2 1/4"	Octagon	3/8" - 16 X 9/16" STL	2700
38-7725-01	2"	2 1/4"	Octagon	1/2" - 13 X 5/8" STL	2700
38-6335-00	2 1/2"	2 5/8"	Octagon	5/8" - 11 X 3/4" AL	3400

MOUNTING BRACKETS

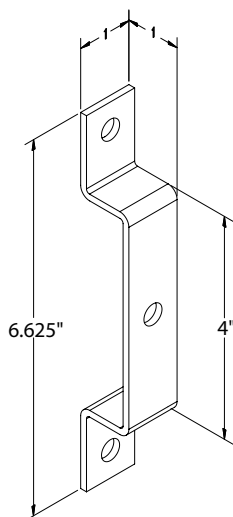

38-7228-00



Catalog Number	Mounting Hole Size	"H"	Kit
38-7230-00	7/16"	1"	Yes
38-7228-00	7/16"	1"	No

- Manufactured from 304 series stainless steel.
- Kit includes two of the assembly (pictured) plus the 3/8" hardware required to mount to a ground bar.
- Mounting Kit uses 38-6333-00 insulators



PERIMETER BUS BARS

thermOweld's perimeter bus bar system is designed to terminate ground wires and cables from equipment and other devices within a structure. The system encompasses straight bars, elbows, splicers, insulators and mounting brackets. This versatile system is great for clean rooms, data centers and laboratories when designing around corners and doors. thermOweld's technical support can help with the designing of your system to meet your design criteria.

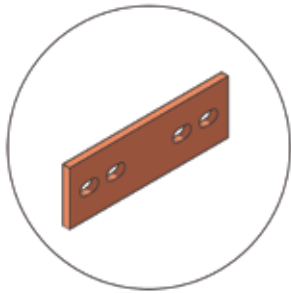

SPB Splice Plate

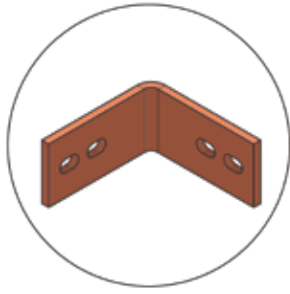

90SPB Splice Plate

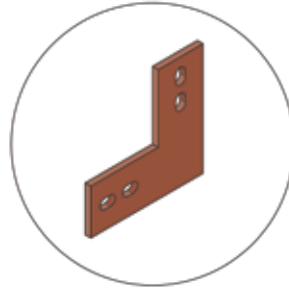

PLB Splice Plate

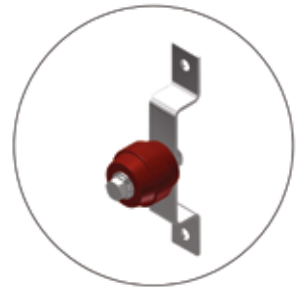

Mounting Kit

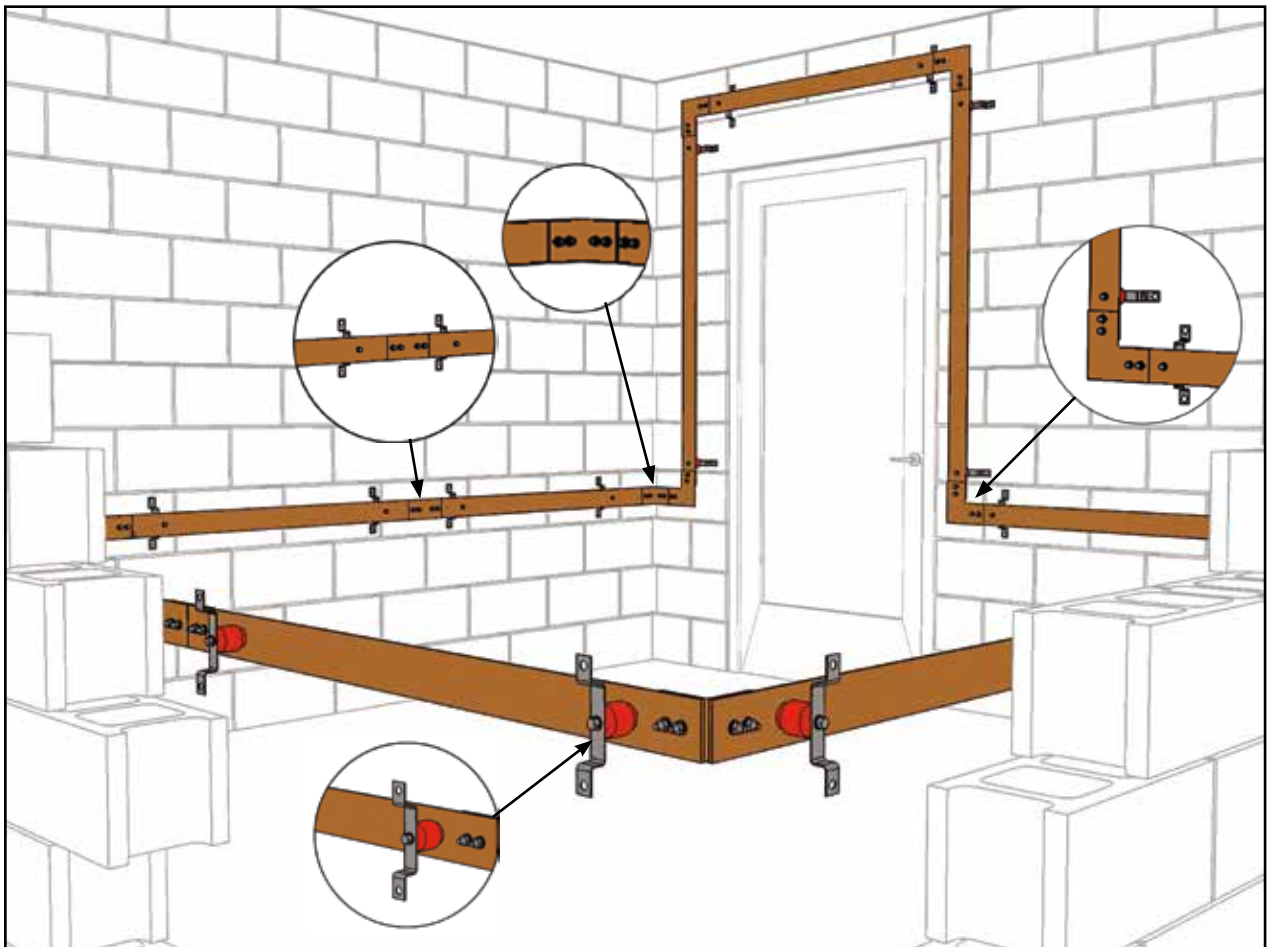

GROUNDING PRODUCTS

PERIMETER BUS BARS

PERIMETER BAR NUMBERING SYSTEM

Below is a guide on how to understand thermOweld's perimeter bus bar numbering system. Each digit of the catalog number represents specific details of our ground bars. Please note that other sizes are available. Contact thermOweld for details.

The example below indicates a plain copper ground bar, 1/4" thick, 10' (120") long, with hole pattern AA, with brackets and insulators.

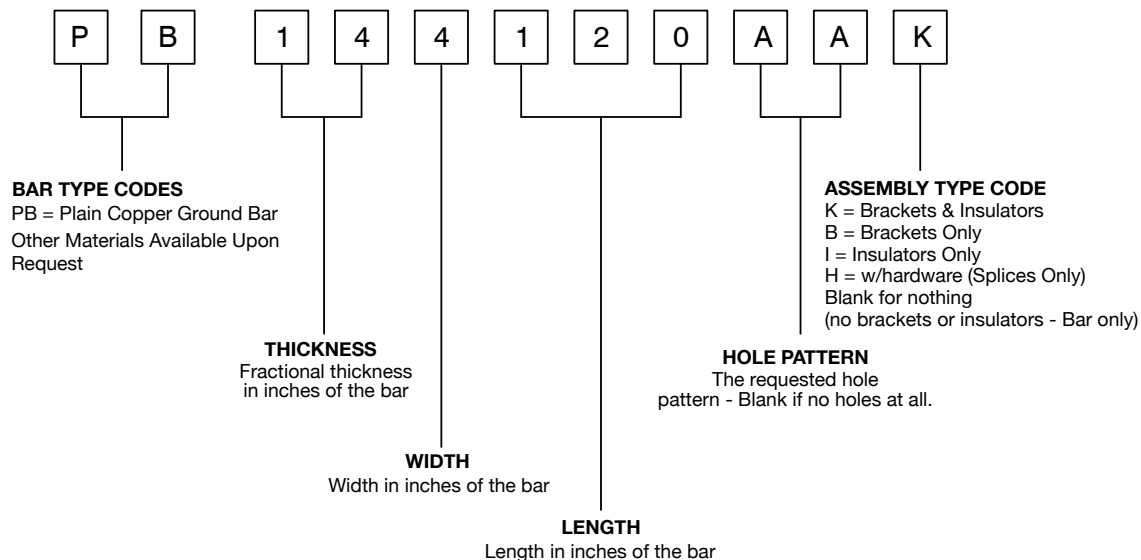

Section 8
Grounding Products

Perimeter Bus Bar Splices	
Catalog Number	Description
SPB1426N	2" SPB Splice Plate
SPB1426NH	2" SPB Splice Plate with Hardware*
SPB1449N	4" SPB Splice Plate
SPB1449NH	4" SPB Splice Plate with Hardware*
90PB1424N	2" 90SPB Splice Plate
90PB1424NH	2" 90SPB Splice Plate with Hardware*
90PB1446N	4" 90SPB Splice Plate
90PB1446NH	4" 90SPB Splice Plate with Hardware*
PLB1425N	2" PLB Splice Plate
PLB1425NH	2" PLB Splice Plate with Hardware*
PLB1448N	4" PLB Splice Plate
PLB1448NH	4" PLB Splice Plate with Hardware*

* Hardware consists of nuts, bolts and washers



Mounting Kit
38-7230-01

GROUNDING PRODUCTS

PERIMETER BUS BARS

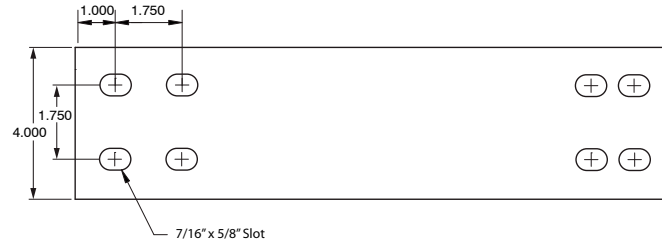

NN Pattern

No hole pattern, except mounting holes, can be made to any length.

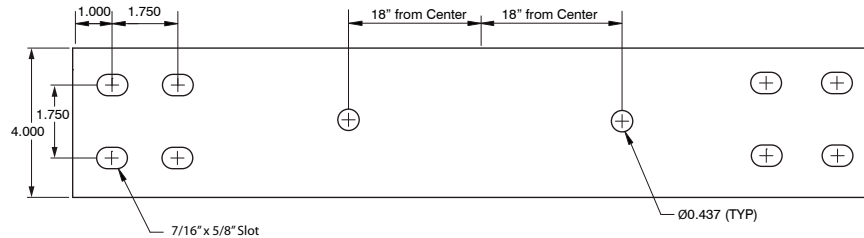
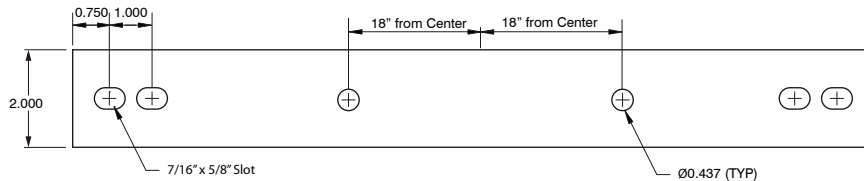

AA Pattern

Holes are spaced 36\"/>

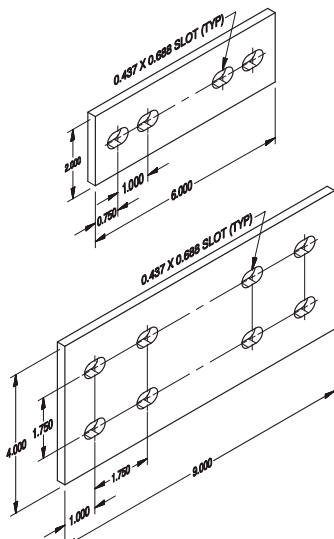

SPB Splice Plate

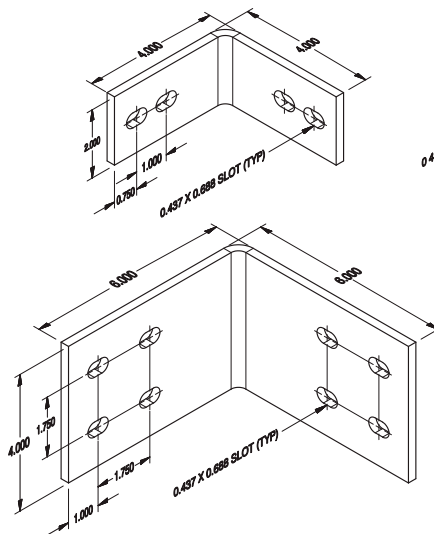

90SPB Splice Plate

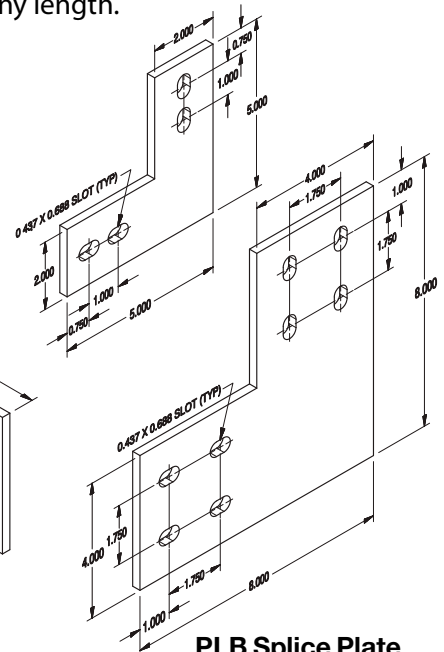

PLB Splice Plate

GROUNDING PRODUCTS

COPPER LUGS

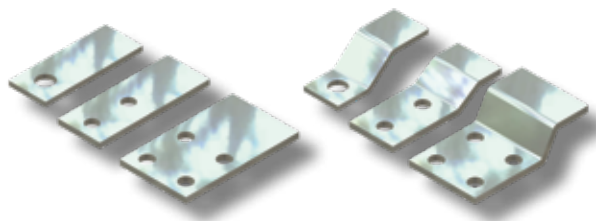

STRAIGHT AND OFFSET COPPER LUGS

thermOweld® straight & offset lugs are designed to be used with CB-1 Type Molds listed on page 62. The lugs are made from electrolytic grade copper bar stock and are tin plated. The lugs are available with one, two or four bolt holes with NEMA spacing. For lug sizes not listed, contact thermOweld®.

Lug Size	Straight Lug Part #	Offset Lug Part #	# Of Holes	Bolt Size	T	W	A	B
1/8 X 1	38-4200-00	38-4150-00	1	3/8	1/8	1	1/2	7/8
1/8 X 1	38-4202-00	38-4152-00	2	1/2	1/8	1	5/8	3
3/16 X 1	38-4203-00	38-4153-00	1	1/2	3/16	1	9/16	1-1/8
3/16 X 1	38-4205-00	38-4155-00	2	1/2	3/16	1	5/8	3
1/4 X 1	38-4206-00	38-4156-00	1	1/2	1/4	1	5/8	1-1/8
1/4 X 1	38-4208-00	38-4158-00	2	1/2	1/4	1	5/8	3
1/4 X 1-1/2	38-4212-00	38-4162-00	1	5/8	1/4	1-1/2	3/4	1-1/2
1/4 X 1-1/2	38-4214-00	38-4164-00	2	1/2	1/4	1-1/2	5/8	3
1/4 X 2	38-3605-00	38-3607-00	2	1/2	1/4	2	5/8	3
3/8 X 1-1/2	38-4215-00	38-4165-00	1	5/8	3/8	1-1/2	3/4	1-1/2
3/8 X 1-1/2	38-4217-00	38-4167-00	2	1/2	3/8	1-1/2	5/8	3
3/8 X 2	38-4218-00	38-4168-00	1	5/8	3/8	2	1	2-1/8
3/8 X 2	38-4220-00	38-4170-00	2	1/2	3/8	2	5/8	3
1/4 X 3	38-4221-00	38-4171-00	4	1/2	1/4	3	5/8	3
3/8 X 3	38-4225-00	38-4175-00	4	1/2	3/8	3	5/8	3
1/2 X 3	38-4226-00	38-4176-00	4	1/2	1/2	3	5/8	3

For sizes not listed, contact thermOweld®.

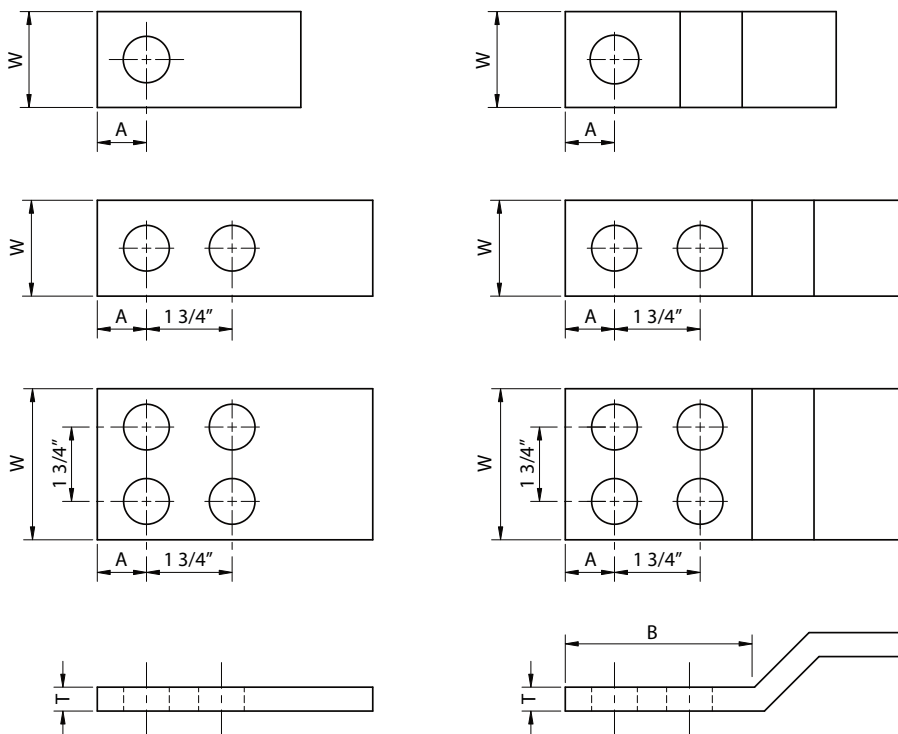

STRAIGHT LUG

OFFSET LUG

COPPER LUGS

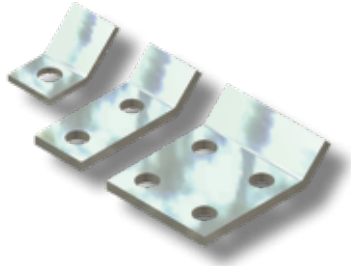

45° COPPER LUGS

thermOweld® 45° lugs are designed to be used with CB-1 Type Molds listed on page 62. The lugs are made from electrolytic grade copper bar stock and tin plated. The lugs are available with one, two or four bolt holes with NEMA spacing. For lug sizes not listed, contact thermOweld®.

Lug Size	45° Lug Part #	# Of Holes	Bolt Size	T	W	A	B
1/8 X 1	38-4227-00	1	3/8	1/8	1	7/16	7/8
1/8 X 1	38-4229-00	2	1/2	1/8	1	5/8	3
3/16 X 1	38-4230-00	1	1/2	3/16	1	5/8	1-1/4
3/16 X 1	38-4232-00	2	1/2	3/16	1	5/8	3
1/4 X 1	38-4233-00	1	1/2	1/4	1	5/8	1-1/4
1/4 X 1	38-4235-00	2	1/2	1/4	1	5/8	3
1/4 X 1-1/2	38-4239-00	1	5/8	1/4	1-1/2	3/4	1-1/2
1/4 X 1-1/2	38-4241-00	2	1/2	1/4	1-1/2	5/8	3
3/8 X 1-1/2	38-4242-00	1	5/8	3/8	1-1/2	3/4	1-1/2
3/8 X 1-1/2	38-4244-00	2	1/2	3/8	1-1/2	5/8	3
3/8 X 2	38-4245-00	1	5/8	3/8	2	3/4	1-1/2
3/8 X 2	38-4247-00	2	1/2	3/8	2	5/8	3
1/4 X 3	38-4248-00	4	1/2	1/4	3	5/8	3
3/8 X 3	38-4252-00	4	1/2	3/8	3	5/8	3
1/2 X 3	38-4253-00	4	1/2	1/2	3	5/8	3

For sizes not listed, contact thermOweld®.

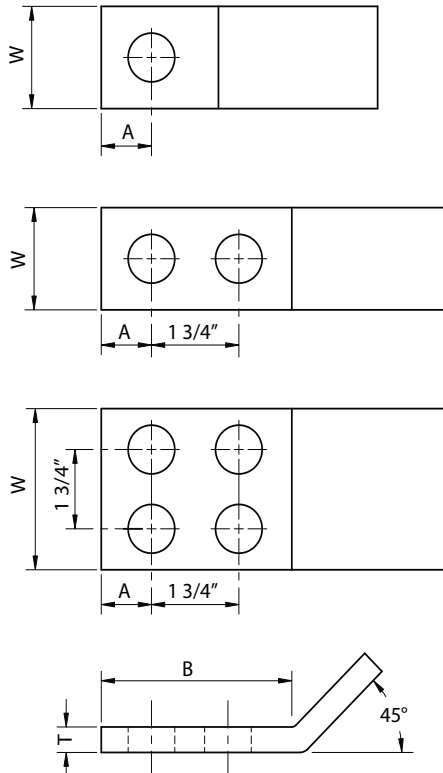

COPPER LUGS

CB-33 STYLE COPPER LUGS

thermOweld® CB-33 Style lugs are designed to be used with CB-33 Type Molds (page 63). The lugs are made from electrolytic grade copper bar stock and are tin plated. The lugs are available with one or two bolt holes with NEMA spacing. For lug sizes not listed, contact thermOweld®.

Lug Size	Lug Part #	# Of Holes	Bolt Size	T	W	A
1/8 X 1	38-4294-00	1	1/2	1/8	1	5/8
1/8 X 1	38-3575-00	2	1/2	1/8	1	5/8
3/16 X 1	38-4293-00	1	1/2	3/16	1	5/8
3/16 X 1	38-4297-00	2	1/2	3/16	1	5/8
1/4 X 1	38-4295-00	1	1/2	1/4	1	5/8
1/4 X 1	38-4298-00	2	1/2	1/4	1	5/8
1/4 X 1-1/2	38-4296-00	1	1/2	1/4	1-1/2	5/8
1/4 X 1-1/2	38-4299-00	2	1/2	1/4	1-1/2	5/8

For sizes not listed, contact thermOweld®.

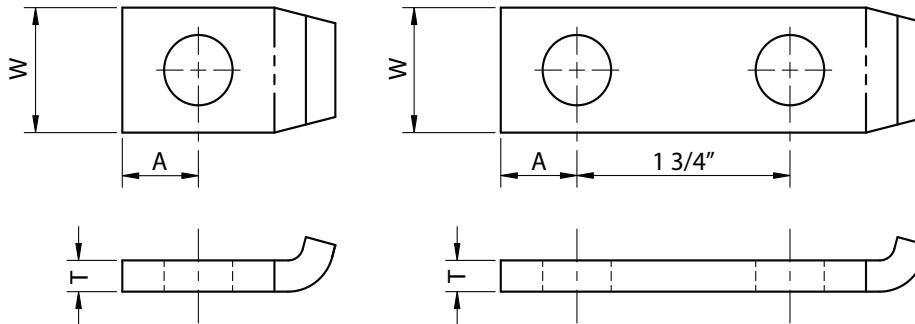

PREFABRICATED LUG BONDS

COPPER LUG BONDS

Prefabricated Lug Bonds and Lug Stub Bonds are made to your specifications. Typical uses for Prefabricated Lug Bonds include cable tray bonding and grounding, structure bonds, surge arrester leads and power jumpers.

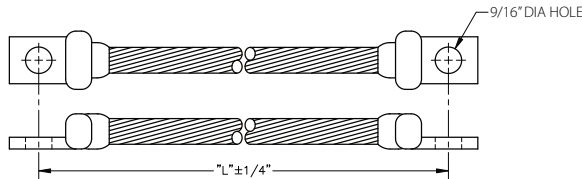

Figure 1

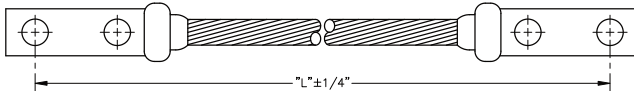

Figure 2

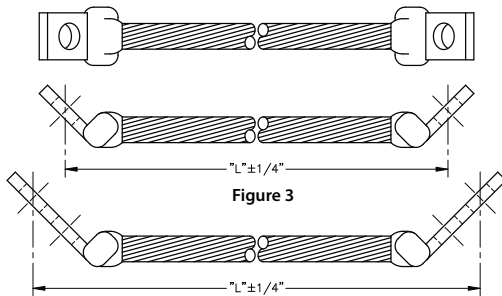

Figure 3

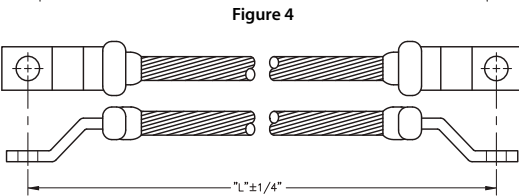

Figure 4

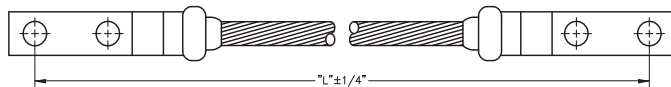
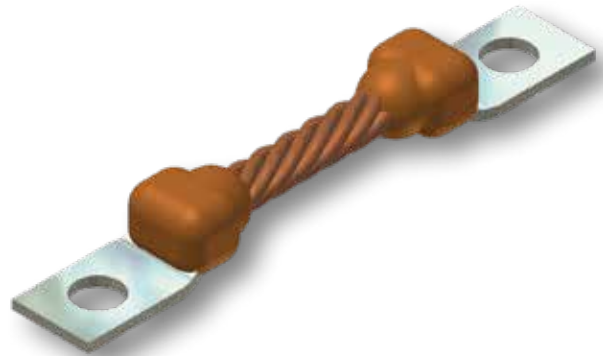

Figure 5



Section 8
Grounding Products

LUG BONDS							
Cable Size	Lug Size	One Hole Figure 1	Two Hole Figure 2	One Hole 45° Figure 3	Two Hole 45° Figure 4	One Hole Offset Figure 5	Two Hole Offset Figure 6
#4	1/8 X 1	38-5672-"L"	38-5673-"L"	38-5674-"L"	38-5675-"L"	38-7311-"L"	TBD
#2	1/8 X 1	38-5676-"L"	38-5677-"L"	38-5678-"L"	38-5679-"L"	TBD	TBD
#1	1/8 X 1	38-5680-"L"	38-5681-"L"	38-5682-"L"	38-5683-"L"	TBD	TBD
1/0	1/8 X 1	38-5684-"L"	38-5685-"L"	38-5686-"L"	38-5687-"L"	TBD	TBD
2/0	1/8 X 1	38-5688-"L"	38-5689-"L"	38-5690-"L"	38-5691-"L"	TBD	TBD
4/0	3/16 X 1	38-5692-"L"	38-5693-"L"	38-5694-"L"	38-5695-"L"	TBD	TBD
250 MCM	3/16 X 1	38-5696-"L"	38-5697-"L"	38-5698-"L"	38-5699-"L"	TBD	TBD

"L" = Length of Bond in inches

For sizes not listed, contact thermOweld®

GROUNDING PRODUCTS

PREFABRICATED LUG BONDS

COPPER LUG STUB BONDS

Prefabricated Lug Bonds and Lug Stub Bonds are made to your specifications. Typical uses for Prefabricated Lug Bonds include cable tray bonding and grounding, structure bonds, surge arrester leads and power jumpers.

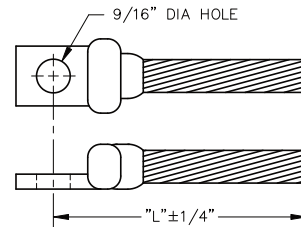

FIGURE 1

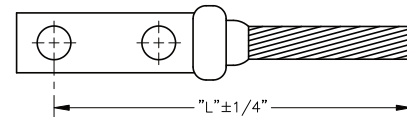

FIGURE 2

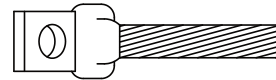

FIGURE 3

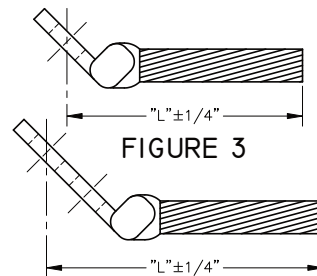

FIGURE 4

LUG STUB BONDS

Cable Size	Lug Size	One Hole Figure 1	Two Hole Figure 2	One Hole 45° Figure 3	Two Hole 45° Figure 4
#4	1/8 X 1	38-5700-"L"	38-5701-"L"	38-5702-"L"	38-5703-"L"
#2	1/8 X 1	38-5704-"L"	38-5705-"L"	38-5706-"L"	38-5707-"L"
#1	1/8 X 1	38-5708-"L"	38-5709-"L"	38-5710-"L"	38-5711-"L"
1/0	1/8 X 1	38-5712-"L"	38-5713-"L"	38-5714-"L"	38-5715-"L"
2/0	1/8 X 1	38-5716-"L"	38-5717-"L"	38-5718-"L"	38-5719-"L"
4/0	3/16 X 1	38-5720-"L"	38-5721-"L"	38-5722-"L"	38-5723-"L"
250 MCM	3/16 X 1	38-5724-"L"	38-5725-"L"	38-5726-"L"	38-5727-"L"

"L" = Length of Bond in inches

For sizes not listed, contact thermOweld®

REBAR BONDS

Rebar Bonding Assemblies consist of Rebar cut to 18" long, with 5' long copper wire attached to the center of the rebar using our CRE-1 exothermic connection.



Rebar Size	Cable Size/Code	Catalog #
#4 x 18"	Q* x 5'	38-7319-00
#4 x 18"	D* x 5'	38-7304-00
#4 x 18"	4/0 x 5'	38-6875-00

* See page 104 for lightning protection cable code.

Contact thermOweld for other cable sizes and custom configurations

UL LISTED PREFABRICATED COPPER GROUND MESH

Prefabricated wire mesh is a simple and cost effective method of enhancing ground systems. Our Prefabricated wire mesh is used in the telecommunication industry to improve grounding and reduce electromagnetic interference. It is also used in power plants and sub-station facilities to reduce potential injury due to electrical discharge.

We manufacture our ground mesh from solid copper or copper clad steel wire. The wire size range from #10 AWG to #4 AWG. We offer ground mesh with no overhang and overlapping ends typical .

Otherwise known as:

Gradient Mesh: Canadian Standards & US -Pipeline
Equipotential Mesh: NEC - Swimming Pools
Personnel Safety Mat: IEEE80
Ground Mesh: UL467

Overlapping Ends

This configuration is designed to allow for side by side connections of adjoining mats; thus providing the easiest method of joining two mesh sections. Adding 2" to one half the conductor spacing provides the overlapping ends. For example, if the mesh size is 6" square, the overlapping end length is 5".

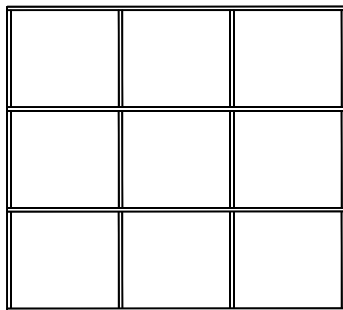

Without Overhang

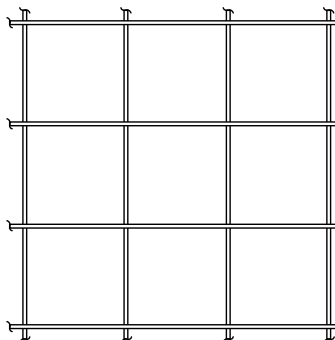

With Overhang

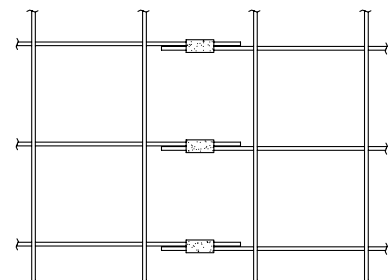

"Overlapping" ends

GROUNDING PRODUCTS

UL LISTED PREFABRICATED COPPER GROUND MESH

GROUND MESH NUMBERING SYSTEM

Example

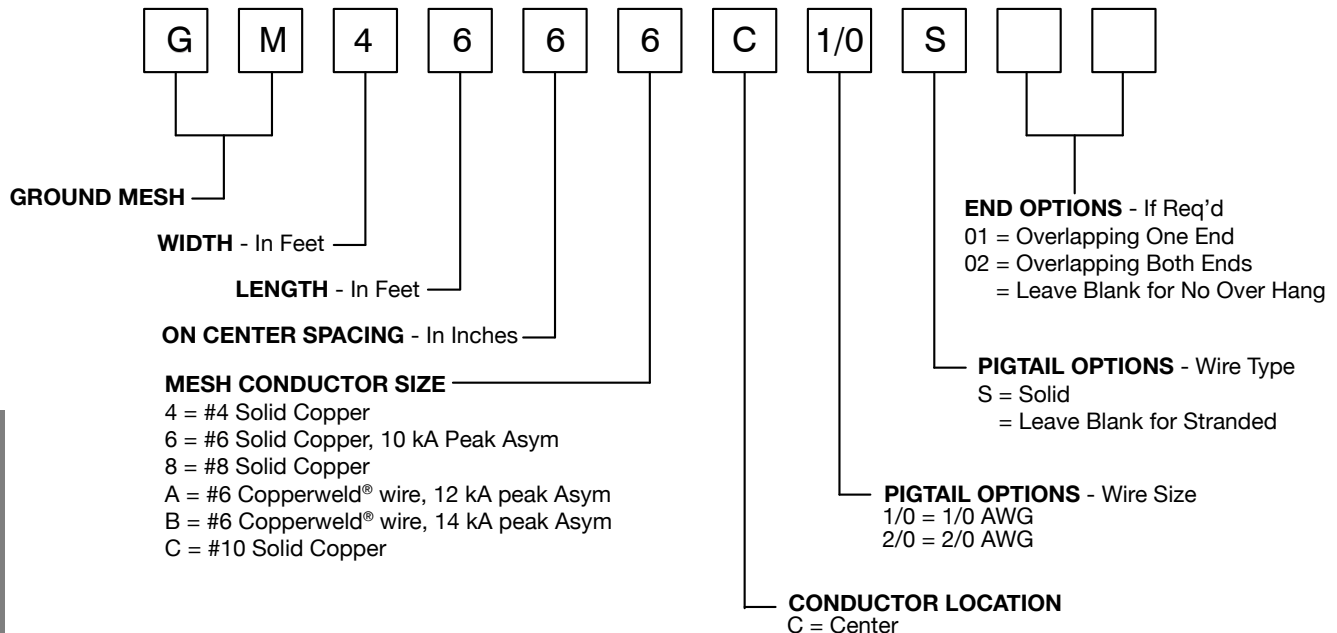

Section 8
Grounding Products

Catalog No.	Description
GM4666C1/0S	4' x 6' x 6" On Center - #6 Solid Copper - Center Conductor 1/0 Solid Pigtail
GM4666	4' x 6' x 6" On Center - #6 Solid Copper
GM468B	4' x 6' x 8" On Center - #6 Copper Clad Steel 40% Conductivity
GM105012801	10' x 50' x 12" On Center - #8 Solid Copper - with Over Hang One End
GM1230126	12' x 30' x 12" On Center - #6 Solid Copper

*Custom sizes and options available upon request, contact thermOweld for details.

NOTES:

- Overlapping ends are equal to 1/2 the spacing plus 2" Don't count overhang for total dimensions.
- Center wire conductors overhang 6" on each end.
- Typical Sizes: 4' x 4', and 4' x 6', Mesh is also available on rolls. Contact factory for details
- Silver Solder Brazed
- Minimum spacing available is 2". UL467 allows 4" to 24" spacing for listing

UL LISTED PREFABRICATED COPPER GROUND MESH

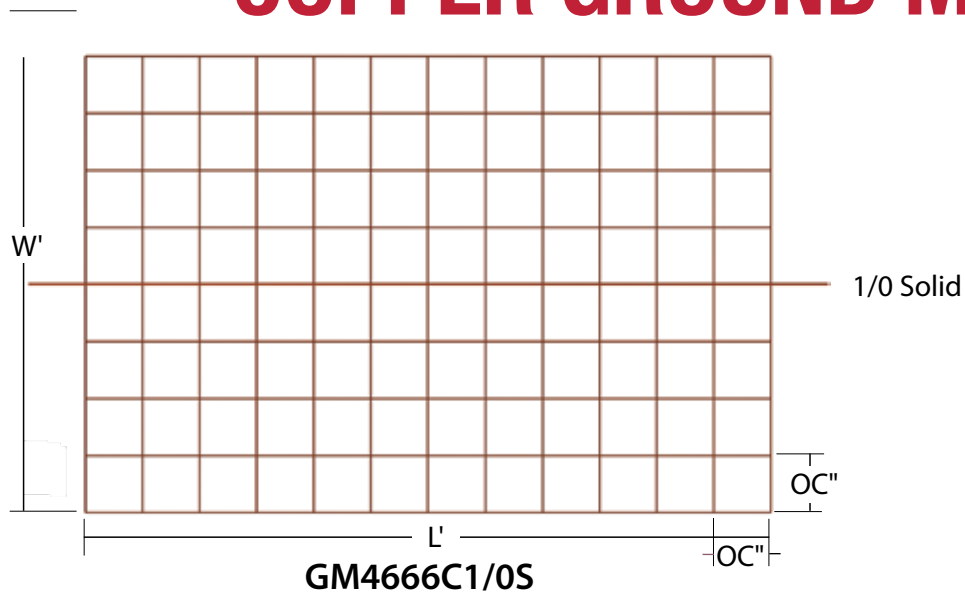

Type		Width (W)	Length (L)	O.C. Spacing	Conductor	Pigtail Options					
G	M	4	6	6	6	C	1	/	0	S	
Ground Mesh		Width in Feet	Length in Feet	On Center Spacing in Inches	Conductor Size and Type	Pigtail Conductor Location, Size and Type					

CC-14

TYPE MOLDS

*Horizontal Parallel through Cables
For AWG Conductors*

MOLDS FOR AWG CONDUCTORS						
Cable		Mold #	Price Key	Weld Metal	Handle Clamps	Lead Time
Run	Tap					
#8	#8	M-1929-S	18†	15	40-4565-00	2
#8 CCS	#8 CCS	M-6210-S	18†	15	40-4565-00	2
#6	#6	M-5618-S	18†	25	40-4565-00	2
#6 CCS	#6 CCS	M-6207	18†	15	40-4565-00	2

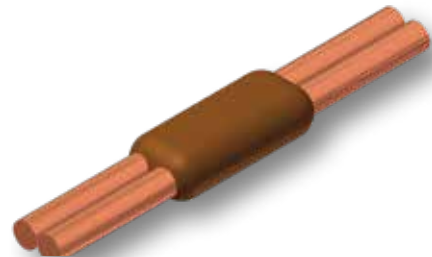

- For sizes not listed, contact thermOweld®.
- Molds listed are for concentric stranded cable. Add suffix "-S" to mold number for solid conductors.
- CCS = Copper Clad Steel
- For molds with wear plates, see page 135.
- For expedited service, contact thermOweld®.
- Required Tools;
 - Handle Clamps w/ Flint Ignitor (see chart for correct handles)
 - 38-0309-00 ~ Flint Ignitor or 38-EZLT-RU EZ Lite Remote®
 - † ~ Sold complete with handles
- Other recommended accessories;
 - 38-3922-00 ~ Mold Cleaning Brush
 - 38-0135-00 ~ Cable Cleaning Brush
 - 38-0330-00 ~ Cable Clamp

GROUNDING PRODUCTS

COPPER GROUND PLATES

Catalog Number	Ground Plate Size	Thickness (Inches)
38-6338-00	18" X 18"	.032
38-6339-00	24" X 24"	.032

- Copper Ground Plate features two dual cable connectors for a secure electrical connection.

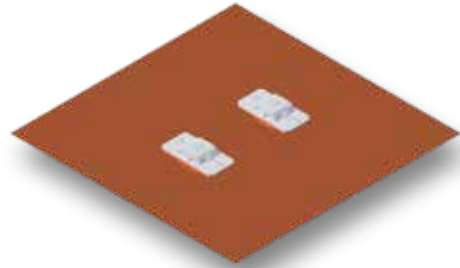

Catalog Number	Ground Plate Size	Thickness (Inches)
38-6338-01	18" X 18"	.032
38-6339-01	24" X 24"	.032

- Same as above except only has a single cable connector.

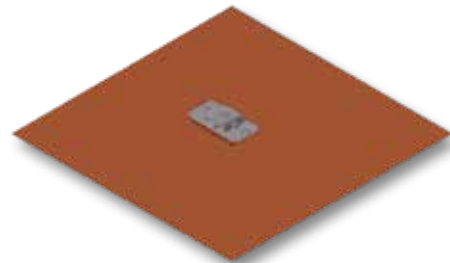

Catalog Number	Ground Plate Size	Thickness (Inches)
38-6340-"X"0	18" X 18"	.032
38-6341-"X"0	24" X 24"	.032

- Copper Ground Plate features an 18" or 24" (depending on the size of the plate) copper conductor exothermically welded to the plate.



Note - "X" When ordering, please specify type of conductor to be used.

1 = #4 STR	4 = 1/0 STR	7 = 250 MCM
2 = #2 SOL	5 = 2/0 STR	8 = 350 MCM
3 = #2 STR	6 = 4/0 STR	9 = 500 MCM

(Example: 38-6340-30 = 18" x 18" Ground Plate w/ #2 STR conductor)

Catalog Number	Ground Plate Size	Thickness (Inches)
38-6342-18	18" X 18"	.25
38-6342-24	24" X 24"	.25

- 1/4" thick bare copper ground plate.
- Field connection required.

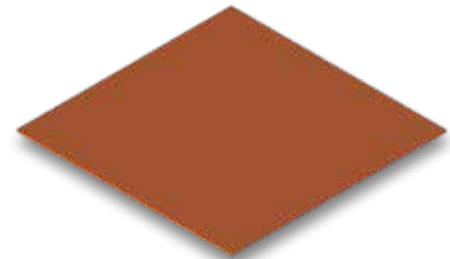

**Other sizes and thicknesses are available.
Please contact factory for details.**

APPLICATION NOTES:

- Copper Ground Plates are used in areas having little or no top soil.
- Can also be used to enhance ground grid systems.
- Can be used in conjunction with earth enhancement material such as Contact.

POLE PLATES

With "One Step Pole Plates," grounding pole equipment is possible without the problems of having to drive a ground rod. Just place the plate in the hole with six inches of Contact GF back fill material below and above the copper plate. Then connect the wire to the pole above the ground line. This easy process is a quick and efficient way to get the job done. See page 145 for Contact GF back fill material.

This installation is equivalent to a ground rod driven into undisturbed soil.

Features

- No need to drive a ground rod when installed as directed.
- Reduces strain and injuries.
- Reduces installation time.
- Reduces grounding errors.
- 100% Copper plate with thermOweld® pigtail.
- Saves time and money.
- Used for grounding Class 5 and larger poles.
- Different configurations available to fit smaller diameter holes.
- Meets the NESC 1997 94.c for ground plates



Catalog Number	Pigtail Size
38-5955-00	10 ft of #6 Solid
38-5955-03	10 ft of #4 Solid
38-5955-04	10 ft of #2 Stranded

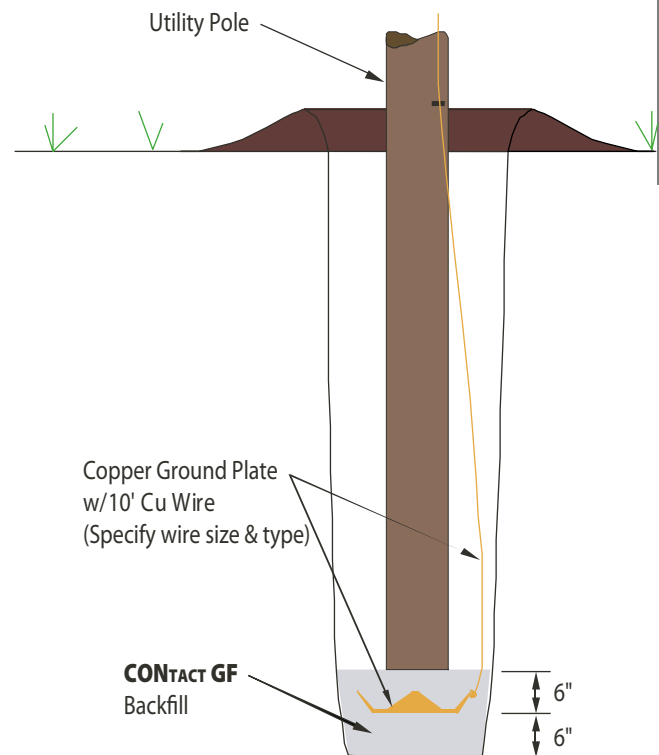

T-WRAP

Part Number 38-6558-00

The National Electric Safety Code (NESC) requires a separate ground at any pole with a transformer installed on it. Many power companies also require a second ground at any pole with equipment. Common practice is to install a ground rod with #6 wire attached to it. This task can sometimes be a problem.

With the T-Wrap you can satisfy this requirement without the problems of driving a ground rod. Just place the plate in the pole hole with 6 inches of Contact GF back fill material below and on top of the T-Wrap. Set the pole on top of the T-Wrap and attach the #6 wire to the pole above the ground line.

This installation is equivalent to a ground rod driven into undisturbed soil.

- Will fit any size wood, concrete or composite pole
- Hole does not need to be augered deeper than normal
- Does not require a larger auger than the one needed to fit pole
- Can be prepped at the yard before transfer to site
- Meets the NESC 1997 94.c for ground plates
- Reduces labor (no need to drive ground rod)
- Reduces impedance
- Works well with ground enhancing products
- Could be used to ground slab mounted transformers

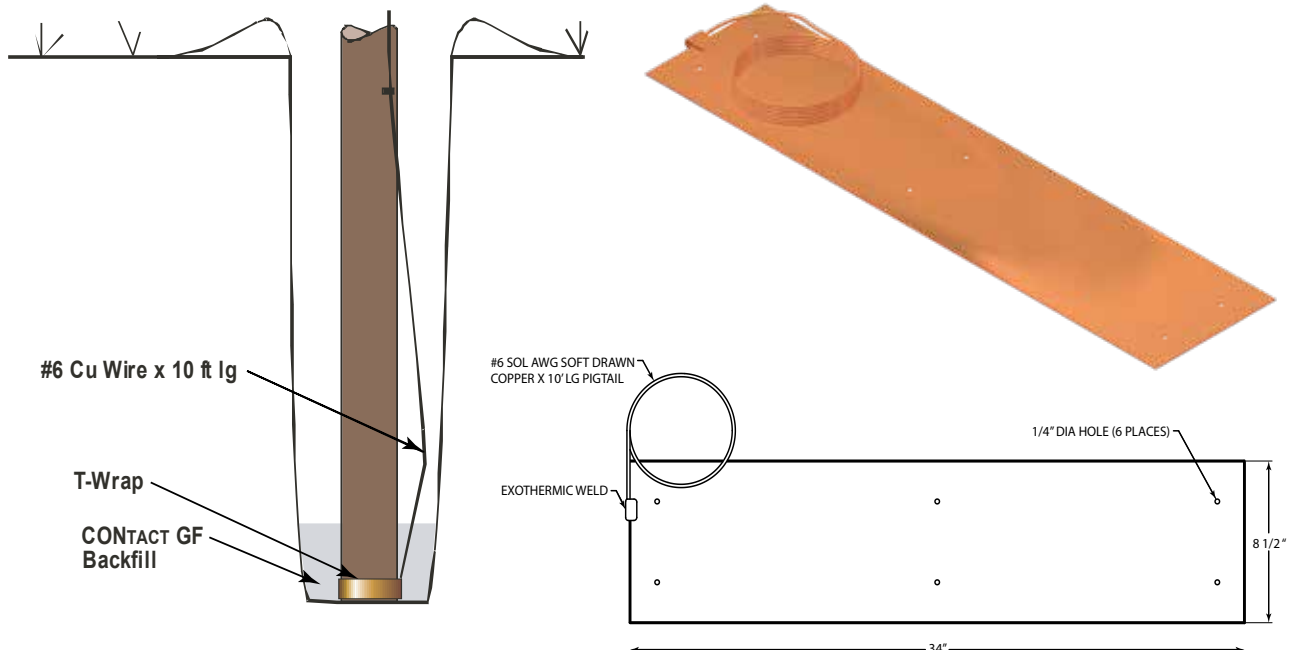

GROUNDING PRODUCTS

BONDING/PIPE CLAMPS

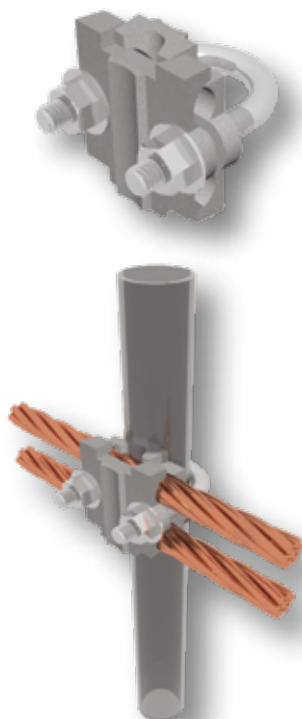

Pipe Range 0.375" - 1"

Cast U-Bolt Pipe Clamps for use with pipe or round bar.

- Manufactured from electroplated tinned bronze or aluminum.
- Wider conductor range; #6 through 250 MCM.
- Features "quick connect", bidirectional design.
- PEM® stud ensures a flush mounting surface.
- Suitable for Direct Burial.

Catalog Number	Material	Description
38-7420-00	Aluminum	1" U-Bolt Bonding Clamp - Fits .400" to 1.375" O.D. Pipe
38-7420-10	Bronze	1" U-Bolt Bonding Clamp - Fits .400" to 1.375" O.D. Pipe
38-7420-11	Tinned	1" U-Bolt Bonding Clamp - Fits .400" to 1.375" O.D. Pipe



Pipe Range 2" - 8"

Catalog Number	Material	Description
38-7421-00	Aluminum	2" U-Bolt Bonding Clamp - Fits 1.315" to 2.000" O.D. Pipe
38-7421-10	Bronze	2" U-Bolt Bonding Clamp - Fits 1.315" to 2.000" O.D. Pipe
38-7421-11	Tinned	2" U-Bolt Bonding Clamp - Fits 1.315" to 2.000" O.D. Pipe
38-7422-00	Aluminum	3" U-Bolt Bonding Clamp - Fits 1.900" to 3.000" O.D. Pipe
38-7422-10	Bronze	3" U-Bolt Bonding Clamp - Fits 1.900" to 3.000" O.D. Pipe
38-7422-11	Tinned	3" U-Bolt Bonding Clamp - Fits 1.900" to 3.000" O.D. Pipe
38-7423-00	Aluminum	4" U-Bolt Bonding Clamp - Fits 2.750" to 4.500" O.D. Pipe
38-7423-10	Bronze	4" U-Bolt Bonding Clamp - Fits 2.750" to 4.500" O.D. Pipe
38-7423-11	Tinned	4" U-Bolt Bonding Clamp - Fits 2.750" to 4.500" O.D. Pipe
38-7424-00	Aluminum	6" U-Bolt Bonding Clamp - Fits 4.500" to 6.750" O.D. Pipe
38-7424-10	Bronze	6" U-Bolt Bonding Clamp - Fits 4.500" to 6.750" O.D. Pipe
38-7424-11	Tinned	6" U-Bolt Bonding Clamp - Fits 4.500" to 6.750" O.D. Pipe
38-7711-00	Aluminum	8" U-Bolt Bonding Clamp - Fits 6.000" to 8.625" O.D. Pipe
38-7711-10	Bronze	8" U-Bolt Bonding Clamp - Fits 6.000" to 8.625" O.D. Pipe
38-7711-11	Tinned	8" U-Bolt Bonding Clamp - Fits 6.000" to 8.625" O.D. Pipe

GROUNDING PRODUCTS

UNIVERSAL PIPE CLAMPS

Catalog Number	Nominal Pipe Size
38-6352-00	.75" to 1.25"
38-6353-00	1.5" to 2"
38-6353-01	2.5" to 3"
38-6353-02	3.5" to 4"
38-6353-03	5" to 6"

- All clamps provide 1-1/2" of contact area to ensure sufficient electrical contact for both ground fault and lightning current.
- These clamps can be connected to ground conductors via exothermic connections and/or standard compression lugs.
- Lug ends are 1/4" x 1" and have holes that are 3/8" diameter 1" on center spacing.
- The Universal Pipe Clamp 38-6352-00 provides bidirectional grounding capabilities making it the perfect connection for grounding fence rail to fence post applications.
- Sizes range from 3/4" up through 6" nominal pipe diameters.
- All clamps are manufactured from highly conductive tinned copper and feature stainless steel hardware.

Section 8
Grounding Products

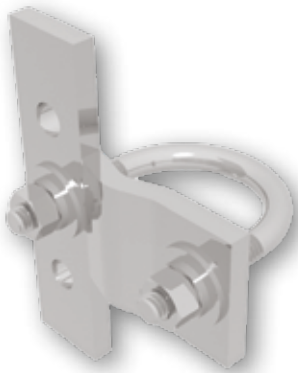

38-6352-00

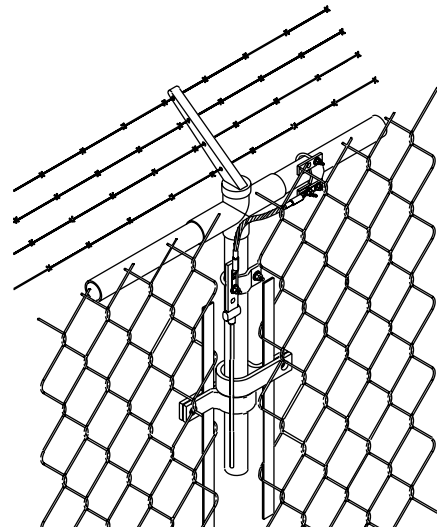

38-6353-XX

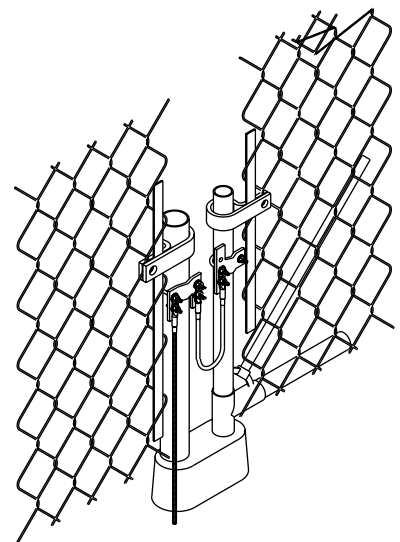
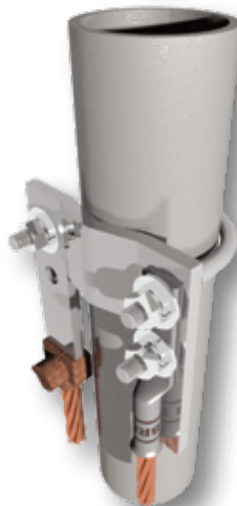

GROUNDING PRODUCTS

FENCE CLAMP ASSEMBLIES



Figure 1
EXAMPLE
0000-38-6007-1D
3" Post

Left Ground Conductor is
#2 AWG Tinned Solid x 24" long
Right Ground Conductor is
No Right Ground Conductor



Figure 2
EXAMPLE
0000-38-6010-6L
4" Post

Left Ground Conductor is
No Left Ground Conductor
Right Ground Conductor is
4/0 Concentric x 144" long

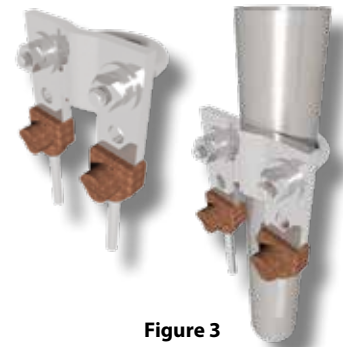

Figure 3
EXAMPLE
0000-38-6013-1D
1.5" Post

Left Ground Conductor is
#2 AWG Tinned Solid x 24" long
Right Ground Conductor is
#2 AWG Tinned Solid x 24" long

Catalog Number	Nominal Pipe Size	Figure
38-6003-†‡	Fits 3/4" to 1 1/4" Post - Left Hand	1
38-6004-†‡	Fits 3/4" to 1 1/4" Post - Right Hand	2
38-6005-†‡	Fits 1 1/2" to 2" Post - Left Hand	1
38-6006-†‡	Fits 1 1/2" to 2" Post - Right Hand	2
38-6007-†‡	Fits 2 1/2" to 3" Post - Left Hand	1
38-6008-†‡	Fits 2 1/2" to 3" Post - Right Hand	2
38-6009-†‡	Fits 3 1/2" to 4" Post - Left Hand	1
38-6010-†‡	Fits 3 1/2" to 4" Post - Right Hand	2
38-6011-†‡	Fits 3/4" to 1 1/4" Post	3
38-6013-†‡	Fits 1 1/2" to 2" Post	3
38-6015-†‡	Fits 2 1/2" to 3" Post	3
38-6017-†‡	Fits 3 1/2" to 4" Post	3

Replace † with the appropriate code from Chart A and ‡ from Chart B. See examples above. For sizes and combinations not listed, contact factory.

Chart A (†)
Ground Conductor Size Codes
1 = #2 AWG Tinned Solid
2 = #2 AWG Concentric
3 = #1 AWG Concentric
4 = 1/0 Concentric
5 = 2/0 Concentric
6 = 4/0 Concentric
7 = 250 MCM Concentric
8 = 300 MCM Concentric
9 = 350 MCM Concentric

Chart B (‡)	
Conductor Length Codes	
A = 6"	G = 10"
B = 12"	H = 96"
C = 18"	J = 60"
D = 24"	K = 72"
E = 36"	L = 144"
F = 48"	M = 30"

GROUNDING PRODUCTS

FLEXIBLE GATE JUMPERS

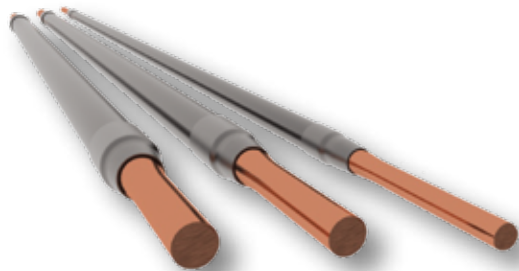

Catalog Number	Jumper Size	Mold Size
38-5532-24	#2	#2 SOLID
38-5533-24	2/0	2/0 STR
38-5534-24	4/0	4/0 STR

- Can be used with the universal pipe clamps or can be exothermically welded to the fence/gate post themselves.
- Three sizes designed to fit either a #2 solid, 2/0 stranded or 4/0 stranded exothermic mold.
- Flex jumpers made from welding cable.
- Standard length is 24" long.

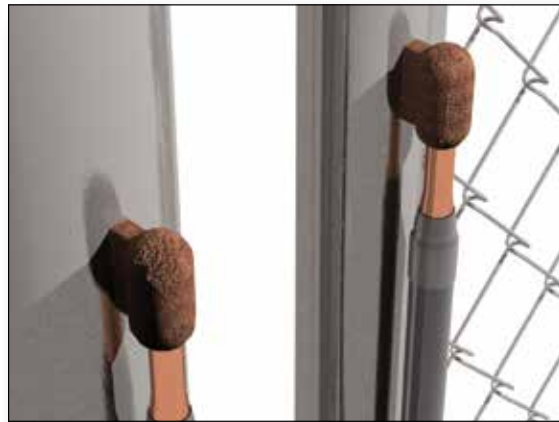

CB-1 Weld Type

Cable Size	Lug Size	Mold #	Weld Metal	Price Key
#2 Sol	1/4" X 1"	M-6667-S	#65	4
2/0	1/4" X 1"	M-981	#65	4
4/0	1/4" X 1"	M-985	#90	4

CS-23 Weld Type

Cable Size	Mold #	Weld Metal	Price Key
#2 Sol	M-2781-SV(P.S.)	#65	4
2/0	M-2540-V(P.S.)	#115	4
4/0	M-8718-V(P.S.)	#150	4

(P.S.) = ADD PIPE SIZE

(EX. M-8718-V3 = 4/0 STR TO 3" VERTICAL PIPE)

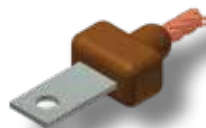

CB-1



CS-23

CS-23 Weld Type (Pipe Range)

Cable Size	Nominal Pipe Size	Mold #	Weld Metal	Price Key
#2 Sol	1 1/4" to 4"	M-6199-S	#65	4
2/0	1 1/4" to 3 1/2" Pipe	M-5495	#90	4
	2" to 4" Pipe	M-7202	#90	4
4/0	1 1/4" to 4" Pipe	M-5622	#150	4

FENCE GATE ASSEMBLIES (EXOTHERMICALLY WELDED)

0000-38-5990-D0
 4" Fence Post
 1.5" Gate Post
 Fence Post is on the **Right**
 4/0 Welding Cable Jumper x 24" long
 No Ground Conductor



Follow the steps outlined below to specify the Fence Clamp Assembly (Exothermically Welded) you need. Replace (#) with the appropriate code from Chart A to specify the flexible jumper size. Contact factory for sizes not listed.

Catalog Number	Description
38-5987-D#	24" Length, Fits 3 1/2" to 4" Gate Post X 3/4" to 1 1/4" Gate Frame - LH
38-5988-D#	24" Length, Fits 3 1/2" to 4" Gate Post X 3/4" to 1 1/4" Gate Frame - RH
38-5989-D#	24" Length, Fits 3 1/2" to 4" Gate Post X 1 1/2" to 2" Gate Frame - LH
38-5990-D#	24" Length, Fits 3 1/2" to 4" Gate Post X 1 1/2" to 2" Gate Frame - RH
38-5991-D#	24" Length, Fits 2 1/2" to 3" Gate Post X 3/4" to 1 1/4" Gate Frame - LH
38-5992-D#	24" Length, Fits 2 1/2" to 3" Gate Post X 3/4" to 1 1/4" Gate Frame - RH
38-5993-D#	24" Length, Fits 2 1/2" to 3" Gate Post X 1 1/2" to 2" Gate Frame - LH
38-5994-D#	24" Length, Fits 2 1/2" to 3" Gate Post X 1 1/2" to 2" Gate Frame - RH
38-5995-D#	24" Length, Fits 1 1/2" to 2" Gate Post X 3/4" to 1 1/4" Gate Frame - LH
38-5996-D#	24" Length, Fits 1 1/2" to 2" Gate Post X 3/4" to 1 1/4" Gate Frame - RH

Chart A (#)
Flexible Jumper Size Codes
2 = #2 AWG Welding Cable
1 = 2/0 AWG Welding Cable
0 = 4/0 AWG Welding Cable

GROUNDING PRODUCTS

FENCE GATE ASSEMBLIES (EXOTHERMICALLY WELDED)



Follow the steps outlined below to specify the Fence Clamp Assembly (Exothermically Welded) you need. Replace (+) with the appropriate code from Chart A to specify the size of the ground conductor and replace (#) with the appropriate code from Chart B to specify the length of the ground conductor.

38-6358-7F
 3" Fence Post
 1.5" Gate Post
 Fence Post is on the **Left**
 4/0 Jumper x 24" long
 250 MCM Ground Conductor x 48" long

Section 8
Grounding Products

Catalog Number	Flexible Jumper	Description	Left/Right Hand
38-6356-++	4/0 W/C	Fits 1 1/2" to 2" Gate Post & 3/4" to 1 1/4" Gate Frame	Left Hand
38-7356-++		Fits 1 1/2" to 2" Gate Post & 3/4" to 1 1/4" Gate Frame	Right Hand
38-6357-++		Fits 2 1/2" to 3" Gate Post & 3/4" to 1 1/4" Gate Frame	Left Hand
38-7357-++		Fits 2 1/2" to 3" Gate Post & 3/4" to 1 1/4" Gate Frame	Right Hand
38-6358-++		Fits 2 1/2" to 3" Gate Post & 1 1/2" to 2" Gate Frame	Left Hand
38-7358-++		Fits 2 1/2" to 3" Gate Post & 1 1/2" to 2" Gate Frame	Right Hand
38-6359-++		Fits 3 1/2" to 4" Gate Post & 3/4" to 1 1/4" Gate Frame	Left Hand
38-7359-++		Fits 3 1/2" to 4" Gate Post & 3/4" to 1 1/4" Gate Frame	Right Hand
38-6360-++		Fits 3 1/2" to 4" Gate Post & 1 1/2" to 2" Gate Frame	Left Hand
38-7360-++		Fits 3 1/2" to 4" Gate Post & 1 1/2" to 2" Gate Frame	Right Hand
38-6361-++	2/0 W/C	Fits 1 1/2" to 2" Gate Post & 3/4" to 1 1/4" Gate Frame	Left Hand
38-7361-++		Fits 1 1/2" to 2" Gate Post & 3/4" to 1 1/4" Gate Frame	Right Hand
38-6362-++		Fits 2 1/2" to 3" Gate Post & 3/4" to 1 1/4" Gate Frame	Left Hand
38-7362-++		Fits 2 1/2" to 3" Gate Post & 3/4" to 1 1/4" Gate Frame	Right Hand
38-6363-++		Fits 2 1/2" to 3" Gate Post & 1 1/2" to 2" Gate Frame	Left Hand
38-7363-++		Fits 2 1/2" to 3" Gate Post & 1 1/2" to 2" Gate Frame	Right Hand
38-6364-++		Fits 3 1/2" to 4" Gate Post & 3/4" to 1 1/4" Gate Frame	Left Hand
38-7364-++		Fits 3 1/2" to 4" Gate Post & 3/4" to 1 1/4" Gate Frame	Right Hand
38-6365-++		Fits 3 1/2" to 4" Gate Post & 1 1/2" to 2" Gate Frame	Left Hand
38-7365-++		Fits 3 1/2" to 4" Gate Post & 1 1/2" to 2" Gate Frame	Right Hand
38-6366-++	#2 W/C	Fits 1 1/2" to 2" Gate Post & 3/4" to 1 1/4" Gate Frame	Left Hand
38-7366-++		Fits 1 1/2" to 2" Gate Post & 3/4" to 1 1/4" Gate Frame	Right Hand
38-6367-++		Fits 2 1/2" to 3" Gate Post & 3/4" to 1 1/4" Gate Frame	Left Hand
38-7367-++		Fits 2 1/2" to 3" Gate Post & 3/4" to 1 1/4" Gate Frame	Right Hand
38-6368-++		Fits 2 1/2" to 3" Gate Post & 1 1/2" to 2" Gate Frame	Left Hand
38-7368-++		Fits 2 1/2" to 3" Gate Post & 1 1/2" to 2" Gate Frame	Right Hand
38-6369-++		Fits 3 1/2" to 4" Gate Post & 3/4" to 1 1/4" Gate Frame	Left Hand
38-7369-++		Fits 3 1/2" to 4" Gate Post & 3/4" to 1 1/4" Gate Frame	Right Hand
38-6370-++		Fits 3 1/2" to 4" Gate Post & 1 1/2" to 2" Gate Frame	Left Hand
38-7370-++		Fits 3 1/2" to 4" Gate Post & 1 1/2" to 2" Gate Frame	Right Hand

Chart A (+)
Ground Conductor Size Codes
1 = #2 Sol (Tinned)
2 = #2 Str
3 = #1 Str
4 = 1/0 Str
5 = 2/0 Str
6 = 4/0 Str
7 = 250 Mcm

Chart B (#)	
Ground Conductor Length Codes	
A = 6"	G = 10"
B = 12"	H = 96"
C = 18"	J = 60"
D = 24"	K = 72"
E = 36"	L = 144"
F = 48"	M = 30"

NOTE:
 All the listed Fence Gate Assemblies come with a 24" long flexible jumper.

FENCE GATE ASSEMBLIES (COMPRESSION LUGS)



Catalog Number	Nominal Gate Post Size Range	Nominal Fence Post Size Range	Jumper Size	Jumper Length
38-6355-00	1.5" to 2"	2.5" to 3"	#2 AWG	24"
38-6355-01	1.5" to 2"	3.5" to 4"	#2 AWG	24"
38-6355-02	1.5" to 2"	5" to 6"	#2 AWG	24"

- Integral component of a fence grounding system.
- Helps eliminate dangerous touch potential.
- Used when it is not feasible to exothermically bond to fence/gate posts.
- Flex jumper assemblies use #2 AWG welding cable.

FENCE FABRIC GROUND CLAMPS

Catalog Number	Conductor Size
38-6354-00	#2
38-6354-01	#2 THRU 4/0
38-6354-02	#8
38-6354-03	#6
38-6354-04	#4
38-6354-05	2/0



- Unique design allows clamp to form connections at most any angle.
- Specific uses include connection to both fence fabric and barbed wire.
- The conductor maintains a direct path to ground while connected to an object that is parallel, perpendicular or in any degree in between.
- Electroplated tinned brass clamp comes complete with stainless steel hardware.
- Allows for use with most metallic surfaces including galvanized.
- Other sizes available. Contact the factory for details.

Fence Ground System

Fence grounding systems are designed to provide protection against dangerous "touch" potentials. The Fence Fabric Ground Clamp is an integral component of this personnel safety system.

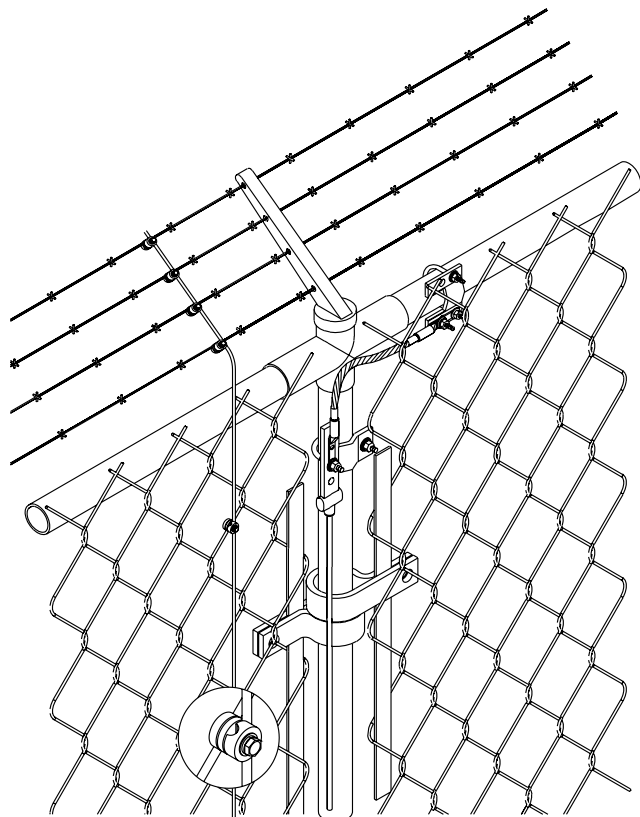
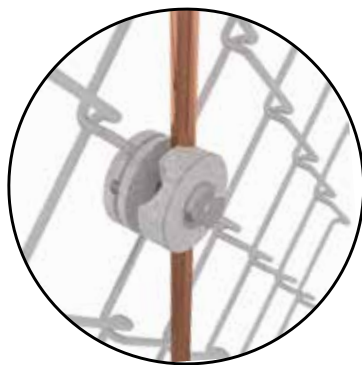

SIGNAL REFERENCE GRID (SRG)

SIGNAL REFERENCE GRIDS ARE:

- Manufactured from 2" x 26 Gage copper strips
- Spaced on 2 ft centers
- Factory welded at each crossover
- Furnished in sections with widths from 4 ft to 18 ft (length limited by weight, approx. 200 lbs)
- Shipped on tubes and protected for transporting
- Interconnected in the field using thermOweld® molds and powder

MOLDS NEEDED TO MAKE SRG CONNECTIONS

SRG Size	Weld Type	Mold #	Price Key	Weld Metal	Handle Clamps	Lead Time
26 Gage X 2"	BB-46	M-6164 †	17	#32	B-106	2
26 Gage X 2"	BB-46	LE-6164 †	17	LE#32	B-106	2
1 x 40 mm & Wider	BB-46	M-9790	17	#45	B-106	2
1 x 40 mm & Wider	BB-46	LE-9790	17	LE#45	B-106	2

† ~ UL Listed

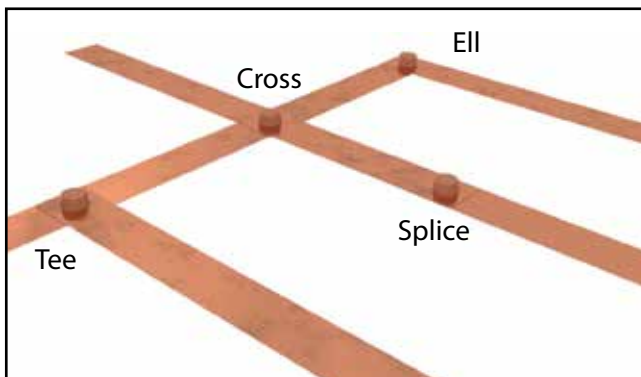

The same thermOweld® mold used to connect adjoining SRG's may be used to make splices, tees, ells or crosses

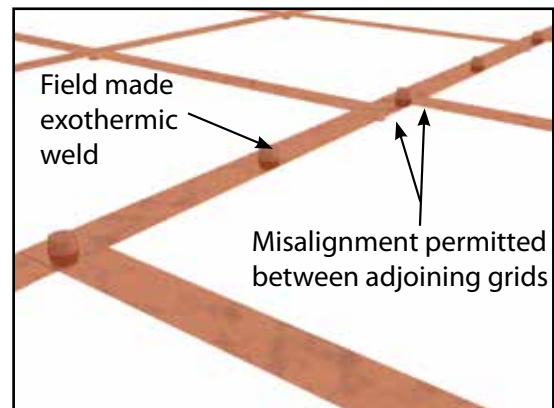

Adjoining sections of SRG are to be exothermically welded by installer using thermOweld® molds and powder

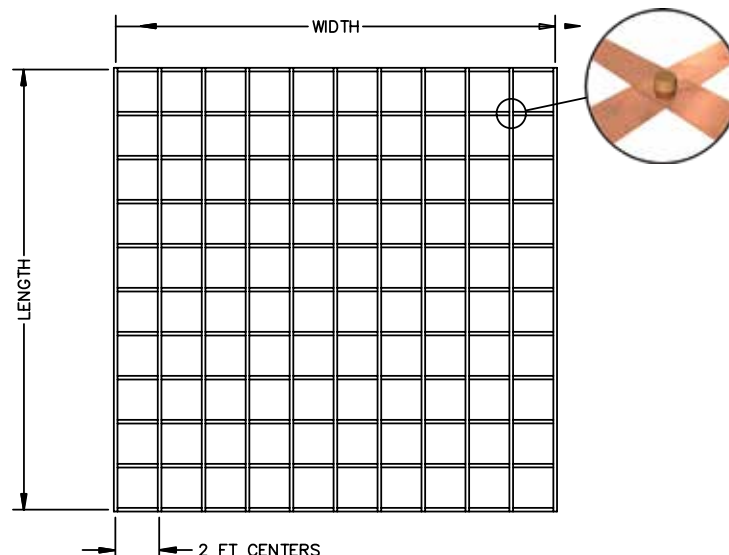

GROUNDING PRODUCTS

LOW IMPEDENCE RISERS (L.I.R.)

Catalog Number	Description
38-5101-"L"	Low Impedance Riser

"L" = Length of L.I.R. in inches (ex. 38-5101-36 is a 36" lg L.I.R.)
 Low Impedance Risers are made from 2" wide x 26" gage copper strip with a 5/16" diameter hole at one end.

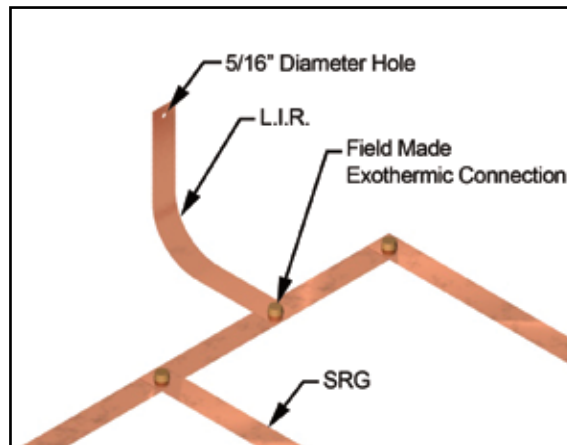

Low Impedance Riser (L.I.R.)
 exothermically welded to SRG

CABLE TO FLOOR PEDESTALS

Section 8
Grounding Products

MOLDS FOR AWG CONDUCTORS							
Cable Size	Pedestal Type	Weld Type	Mold #	Price Key	Weld Metal	Handle Clamps	Lead Time
#6	1" ROUND	CS-6	M-6124	33	#15	40-4565-00	2
#6	1" ROUND	CS-6	LE-6124	33	LE#15	40-4565-00	4
#6	7/8" SQUARE	CS-27	M-6125	33	#15	40-4565-00	2
#6	7/8" SQUARE	CS-27	LE-6125	33	LE#15	40-4565-00	4
#6	1" ROUND	CS-3	M-6609	33	#15	40-4565-00	2
#6	1" ROUND	CS-3	LE-6609	33	LE#15	40-4565-00	4
#6	7/8" SQUARE	CS-3	M-6610	33	#15	40-4565-00	2
#6	7/8" SQUARE	CS-3	LE-6610	33	LE#15	40-4565-00	4
#4	1" ROUND	CS-6	M-6252	33	#15	40-4565-00	2
#4	1" ROUND	CS-6	LE-6252	33	LE#15	40-4565-00	4
#4	7/8" SQUARE	CS-27	M-8502	33	#15	40-4565-00	2
#4	7/8" SQUARE	CS-27	LE-8502	33	LE#15	40-4565-00	4
#4	1" ROUND	CS-3	M-6783	33	#15	40-4565-00	4
#4	1" ROUND	CS-3	LE-6783	33	LE#15	40-4565-00	4
#4	7/8" SQUARE	CS-3	M-6784	33	#15	40-4565-00	4
#4	7/8" SQUARE	CS-3	LE-6784	33	LE#15	40-4565-00	4
#2	1" ROUND	CS-6	M-8863	33	#15	40-4565-00	2
#2	1" ROUND	CS-6	LE-8863	33	LE#15	40-4565-00	4
#2	7/8" SQUARE	CS-27	M-8743	33	#15	40-4565-00	4
#2	7/8" SQUARE	CS-27	LE-8743	33	LE#15	40-4565-00	4
#2	1" ROUND	CS-3	M-6785	33	#15	40-4565-00	4
#2	1" ROUND	CS-3	LE-6785	33	LE#15	40-4565-00	4
#2	7/8" SQUARE	CS-3	M-6786	33	#15	40-4565-00	4
#2	7/8" SQUARE	CS-3	LE-6786	33	LE#15	40-4565-00	4



Bonding conductor exothermically welded to
 round and square floor pedestals

CABLE TO (SRG) CONNECTIONS



MOLDS FOR AWG CONDUCTORS						
Cable Size	Weld Type	Mold #	Price Key	Weld Metal	Handle Clamps	Lead Time
#6	CB-34	M-2763	4	#25	B-106	2
#6	CB-34	LE-2763	4	LE#25	B-106	4
#4	CB-34	M-6253	4	#32	B-106	2
#4	CB-34	LE-6253	4	LE#32	B-106	4
#2	CB-34	M-6254	4	#32	B-106	2
#2	CB-34	LE-6254	4	LE#32	B-106	4
1/0	CB-34	M-5454	4	65	B-106	2
1/0	CB-34	LE-5454	4	LE65	B-106	4
2/0	CB-34	M-8583	4	#65	B-106	2
2/0	CB-34	LE-8583	4	LE#65	B-106	4

CABLE TO VERTICAL STEEL CONNECTIONS



MOLDS FOR AWG CONDUCTORS						
Cable Size	Weld Type	Mold #	Price Key	Weld Metal	Handle Clamps	Lead Time
#6	CS-3	M-8848 †	18	#25	40-4565-00	2
#6	CS-3	LE-8848 †	19	LE#25	40-4565-00	4
#4	CS-3	M-586	4	#45	B-106	2
#4	CS-3	LE-586	4	LE#45	B-106	4
#2	CS-3	M-588	4	#45	B-106	SDS
#2	CS-3	LE-588	4	LE#45	B-106	4

† Requires 38-0202-00 copper adapter sleeve

CABLE TO LUG CONNECTION

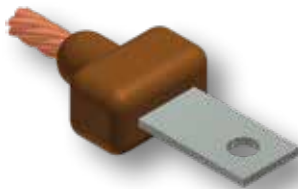

MOLDS FOR AWG CONDUCTORS						
Cable Size	Weld Type	Mold #	Price Key	Weld Metal	Handle Clamps	Lead Time
#6	CB-1	M-6255	18	#25	40-4565-00	2
#6	CB-1	LE-6255	19	LE#25	40-4565-00	4
#4	CB-1	M-6257	18	#25	40-4565-00	4
#4	CB-1	LE-6257	19	LE#25	40-4565-00	4
#2	CB-1	M-6258	18	#32	40-4565-00	4
#2	CB-1	LE-6258	19	LE#3	40-4565-00	2

1/16" x 1/2" lug with 1/4" dia hole - Part #38-4709-00
Contact factory for other lug sizes.

GROUNDING PRODUCTS

COMPUTER ROOM GROUND CLAMPS



Catalog Number	Conductor Size
38-6348-00	#6 STR
38-6348-01	#4 STR
38-6348-02	#2 STR

Used when welded connections are not feasible.
Unique design allows clamps to form connections at most any angle.
Specific uses include fabrication under an existing computer room floor.

